

## **ARTICLE 14. ONE AND TWO FAMILY DWELLING CODE**

### **Rule 1. Indiana One and Two Family Dwelling Code (Repealed)**

*(Repealed by Fire Prevention and Building Safety Commission; filed Aug 27, 1990, 3:20 p.m.: 14 IR 134, eff Nov 1, 1990)*

### **Rule 2. Amendments to the Adopted CABO One and Two Family Dwelling Code (Repealed)**

*(Repealed by Fire Prevention and Building Safety Commission; filed Jan 15, 1987, 10:40 am: 10 IR 1272, eff Mar 1, 1987)*

### **Rule 2.1. CABO One and Two Family Dwelling Code; Amendments**

#### **675 IAC 14-2.1-1 Scope (Repealed)**

*Sec. 1. (Repealed by Fire Prevention and Building Safety Commission; filed Aug 27, 1990, 3:20 p.m.: 14 IR 134, eff Nov 1, 1990)*

#### **675 IAC 14-2.1-2 Authority (Repealed)**

*Sec. 2. (Repealed by Fire Prevention and Building Safety Commission; filed Aug 27, 1990, 3:20 p.m.: 14 IR 134, eff Nov 1, 1990)*

#### **675 IAC 14-2.1-3 Violations (Repealed)**

*Sec. 3. (Repealed by Fire Prevention and Building Safety Commission; filed Aug 27, 1990, 3:20 p.m.: 14 IR 134, eff Nov 1, 1990)*

#### **675 IAC 14-2.1-4 Penalty (Repealed)**

*Sec. 4. (Repealed by Fire Prevention and Building Safety Commission; filed Aug 27, 1990, 3:20 p.m.: 14 IR 134, eff Nov 1, 1990)*

#### **675 IAC 14-2.1-5 Right of appeal (Repealed)**

*Sec. 5. (Repealed by Fire Prevention and Building Safety Commission; filed Aug 27, 1990, 3:20 p.m.: 14 IR 134, eff Nov 1, 1990)*

#### **675 IAC 14-2.1-6 Alternate materials, methods and designs (Repealed)**

*Sec. 6. (Repealed by Fire Prevention and Building Safety Commission; filed Aug 27, 1990, 3:20 p.m.: 14 IR 134, eff Nov 1, 1990)*

#### **675 IAC 14-2.1-7 Permit required (Repealed)**

*Sec. 7. (Repealed by Fire Prevention and Building Safety Commission; filed Aug 27, 1990, 3:20 p.m.: 14 IR 134, eff Nov 1, 1990)*

#### **675 IAC 14-2.1-8 Other inspections (Repealed)**

*Sec. 8. (Repealed by Fire Prevention and Building Safety Commission; filed Aug 27, 1990, 3:20 p.m.: 14 IR 134, eff Nov 1, 1990)*

#### **675 IAC 14-2.1-9 Approval required (Repealed)**

*Sec. 9. (Repealed by Fire Prevention and Building Safety Commission; filed Aug 27, 1990, 3:20 p.m.: 14 IR 134, eff Nov 1, 1990)*

1990)

**675 IAC 14-2.1-10 Existing installations (Repealed)**

Sec. 10. *(Repealed by Fire Prevention and Building Safety Commission; filed Aug 27, 1990, 3:20 p.m.: 14 IR 134, eff Nov 1, 1990)*

**675 IAC 14-2.1-11 Definitions (Repealed)**

Sec. 11. *(Repealed by Fire Prevention and Building Safety Commission; filed Aug 27, 1990, 3:20 p.m.: 14 IR 134, eff Nov 1, 1990)*

**675 IAC 14-2.1-12 Climatic and geographic criteria (Repealed)**

Sec. 12. *(Repealed by Fire Prevention and Building Safety Commission; filed Aug 27, 1990, 3:20 p.m.: 14 IR 134, eff Nov 1, 1990)*

**675 IAC 14-2.1-13 Workmanship (Repealed)**

Sec. 13. *(Repealed by Fire Prevention and Building Safety Commission; filed Aug 27, 1990, 3:20 p.m.: 14 IR 134, eff Nov 1, 1990)*

**675 IAC 14-2.1-14 Parapets (Repealed)**

Sec. 14. *(Repealed by Fire Prevention and Building Safety Commission; filed Aug 27, 1990, 3:20 p.m.: 14 IR 134, eff Nov 1, 1990)*

**675 IAC 14-2.1-15 Structural independence (Repealed)**

Sec. 15. *(Repealed by Fire Prevention and Building Safety Commission; filed Feb 8, 1988, 10:03 am: 11 IR 1796)*

**675 IAC 14-2.1-16 Bathrooms (Repealed)**

Sec. 16. *(Repealed by Fire Prevention and Building Safety Commission; filed Aug 27, 1990, 3:20 p.m.: 14 IR 134, eff Nov 1, 1990)*

**675 IAC 14-2.1-17 Heating (Repealed)**

Sec. 17. *(Repealed by Fire Prevention and Building Safety Commission; filed Aug 27, 1990, 3:20 p.m.: 14 IR 134, eff Nov 1, 1990)*

**675 IAC 14-2.1-18 Hazardous locations (Repealed)**

Sec. 18. *(Repealed by Fire Prevention and Building Safety Commission; filed Aug 27, 1990, 3:20 p.m.: 14 IR 134, eff Nov 1, 1990)*

**675 IAC 14-2.1-19 Attached garages (Repealed)**

Sec. 19. *(Repealed by Fire Prevention and Building Safety Commission; filed Aug 27, 1990, 3:20 p.m.: 14 IR 134, eff Nov 1, 1990)*

**675 IAC 14-2.1-20      Garages, carports and accessory structures (Repealed)**

Sec. 20. *(Repealed by Fire Prevention and Building Safety Commission; filed Aug 27, 1990, 3:20 p.m.: 14 IR 134, eff Nov 1, 1990)*

**675 IAC 14-2.1-21      Emergency egress openings (Repealed)**

Sec. 21. *(Repealed by Fire Prevention and Building Safety Commission; filed Aug 27, 1990, 3:20 p.m.: 14 IR 134, eff Nov 1, 1990)*

**675 IAC 14-2.1-22      Landings (Repealed)**

Sec. 22. *(Repealed by Fire Prevention and Building Safety Commission; filed Aug 27, 1990, 3:20 p.m.: 14 IR 134, eff Nov 1, 1990)*

**675 IAC 14-2.1-23      Spiral stairs and winders (Repealed)**

Sec. 23. *(Repealed by Fire Prevention and Building Safety Commission; filed Aug 27, 1990, 3:20 p.m.: 14 IR 134, eff Nov 1, 1990)*

**675 IAC 14-2.1-24      Smoke detector required (Repealed)**

Sec. 24. *(Repealed by Fire Prevention and Building Safety Commission; filed Aug 27, 1990, 3:20 p.m.: 14 IR 134, eff Nov 1, 1990)*

**675 IAC 14-2.1-25      Attics and crawlspaces (Repealed)**

Sec. 25. *(Repealed by Fire Prevention and Building Safety Commission; filed Aug 27, 1990, 3:20 p.m.: 14 IR 134, eff Nov 1, 1990)*

**675 IAC 14-2.1-26      Climatic and geographic design criteria; Table No. R-202 (Repealed)**

Sec. 26. *(Repealed by Fire Prevention and Building Safety Commission; filed Aug 27, 1990, 3:20 p.m.: 14 IR 134, eff Nov 1, 1990)*

**675 IAC 14-2.1-27      Minimum uniformly distributed live loads; Table No. R-202.4 (Repealed)**

Sec. 27. *(Repealed by Fire Prevention and Building Safety Commission; filed Aug 27, 1990, 3:20 p.m.: 14 IR 134, eff Nov 1, 1990)*

**675 IAC 14-2.1-28      Roof live loads; Figure No. R-202.1 (Repealed)**

Sec. 28. *(Repealed by Fire Prevention and Building Safety Commission; filed Aug 27, 1990, 3:20 p.m.: 14 IR 134, eff Nov 1, 1990)*

**675 IAC 14-2.1-29      Frost line depth; Figure No. R-202.2 (Repealed)**

Sec. 29. *(Repealed by Fire Prevention and Building Safety Commission; filed Aug 27, 1990, 3:20 p.m.: 14 IR 134, eff Nov 1, 1990)*

**675 IAC 14-2.1-30      Detached garages, detached carports or accessory structures; Table No. R-210 (Repealed)**

Sec. 30. *(Repealed by Fire Prevention and Building Safety Commission; filed Aug 27, 1990, 3:20 p.m.: 14 IR 134, eff Nov 1, 1990)*

**675 IAC 14-2.1-31 Soil test (Repealed)**

Sec. 31. *(Repealed by Fire Prevention and Building Safety Commission; filed Aug 27, 1990, 3:20 p.m.: 14 IR 134, eff Nov 1, 1990)*

**675 IAC 14-2.1-32 Concrete (Repealed)**

Sec. 32. *(Repealed by Fire Prevention and Building Safety Commission; filed Aug 27, 1990, 3:20 p.m.: 14 IR 134, eff Nov 1, 1990)*

**675 IAC 14-2.1-33 Footings (Repealed)**

Sec. 33. *(Repealed by Fire Prevention and Building Safety Commission; filed Aug 27, 1990, 3:20 p.m.: 14 IR 134, eff Nov 1, 1990)*

**675 IAC 14-2.1-34 Backfill damage (Repealed)**

Sec. 34. *(Repealed by Fire Prevention and Building Safety Commission; filed Aug 27, 1990, 3:20 p.m.: 14 IR 134, eff Nov 1, 1990)*

**675 IAC 14-2.1-35 Drains required (Repealed)**

Sec. 35. *(Repealed by Fire Prevention and Building Safety Commission; filed Aug 27, 1990, 3:20 p.m.: 14 IR 134, eff Nov 1, 1990)*

**675 IAC 14-2.1-36 Dampproofing for concrete and masonry foundations (Repealed)**

Sec. 36. *(Repealed by Fire Prevention and Building Safety Commission; filed Aug 27, 1990, 3:20 p.m.: 14 IR 134, eff Nov 1, 1990)*

**675 IAC 14-2.1-37 Location required (Repealed)**

Sec. 37. *(Repealed by Fire Prevention and Building Safety Commission; filed Aug 27, 1990, 3:20 p.m.: 14 IR 134, eff Nov 1, 1990)*

**675 IAC 14-2.1-38 Drainage (Repealed)**

Sec. 38. *(Repealed by Fire Prevention and Building Safety Commission; filed Aug 27, 1990, 3:20 p.m.: 14 IR 134, eff Nov 1, 1990)*

**675 IAC 14-2.1-39 Minimum specified compressive strength of concrete; Table No. R-302.3 (Repealed)**

Sec. 39. *(Repealed by Fire Prevention and Building Safety Commission; filed Aug 27, 1990, 3:20 p.m.: 14 IR 134, eff Nov 1, 1990)*

**675 IAC 14-2.1-40 Minimum foundation requirements; Figure No. R-303 (Repealed)**

Sec. 40. *(Repealed by Fire Prevention and Building Safety Commission; filed Aug 27, 1990, 3:20 p.m.: 14 IR 134, eff Nov 1, 1990)*

1990)

**675 IAC 14-2.1-41 Construction (Repealed)**

Sec. 41. *(Repealed by Fire Prevention and Building Safety Commission; filed Aug 27, 1990, 3:20 p.m.: 14 IR 134, eff Nov 1, 1990)*

**675 IAC 14-2.1-42 Cutting and notching (Repealed)**

Sec. 42. *(Repealed by Fire Prevention and Building Safety Commission; filed Aug 27, 1990, 3:20 p.m.: 14 IR 134, eff Nov 1, 1990)*

**675 IAC 14-2.1-43 Firestopping (Repealed)**

Sec. 43. *(Repealed by Fire Prevention and Building Safety Commission; filed Aug 27, 1990, 3:20 p.m.: 14 IR 134, eff Nov 1, 1990)*

**675 IAC 14-2.1-44 Draftstopping (Repealed)**

Sec. 44. *(Repealed by Fire Prevention and Building Safety Commission; filed Aug 27, 1990, 3:20 p.m.: 14 IR 134, eff Nov 1, 1990)*

**675 IAC 14-2.1-45 Plywood (Repealed)**

Sec. 45. *(Repealed by Fire Prevention and Building Safety Commission; filed Aug 27, 1990, 3:20 p.m.: 14 IR 134, eff Nov 1, 1990)*

**675 IAC 14-2.1-46 Fastener schedule for structural members; Table No. R-402.3.2 (Repealed)**

Sec. 46. *(Repealed by Fire Prevention and Building Safety Commission; filed Aug 27, 1990, 3:20 p.m.: 14 IR 134, eff Nov 1, 1990)*

**675 IAC 14-2.1-47 Figure No. R-402.3.2 (Repealed)**

Sec. 47. *(Repealed by Fire Prevention and Building Safety Commission; filed Aug 27, 1990, 3:20 p.m.: 14 IR 134, eff Nov 1, 1990)*

**675 IAC 14-2.1-48 Flashing (Repealed)**

Sec. 48. *(Repealed by Fire Prevention and Building Safety Commission; filed Aug 27, 1990, 3:20 p.m.: 14 IR 134, eff Nov 1, 1990)*

**675 IAC 14-2.1-49 Flashing (Repealed)**

Sec. 49. *(Repealed by Fire Prevention and Building Safety Commission; filed Aug 27, 1990, 3:20 p.m.: 14 IR 134, eff Nov 1, 1990)*

**675 IAC 14-2.1-50 Weather-resistant siding attachment and minimum thickness; Table No. R-503.6 (Repealed)**

Sec. 50. *(Repealed by Fire Prevention and Building Safety Commission; filed Aug 27, 1990, 3:20 p.m.: 14 IR 134, eff Nov 1, 1990)*

**675 IAC 14-2.1-51 Bearing (Repealed)**

Sec. 51. *(Repealed by Fire Prevention and Building Safety Commission; filed Aug 27, 1990, 3:20 p.m.: 14 IR 134, eff Nov 1, 1990)*

**675 IAC 14-2.1-52 Base (Repealed)**

Sec. 52. *(Repealed by Fire Prevention and Building Safety Commission; filed Aug 27, 1990, 3:20 p.m.: 14 IR 134, eff Nov 1, 1990)*

**675 IAC 14-2.1-53 Floor underlayment (Repealed)**

Sec. 53. *(Repealed by Fire Prevention and Building Safety Commission; filed Aug 27, 1990, 3:20 p.m.: 14 IR 134, eff Nov 1, 1990)*

**675 IAC 14-2.1-54 Floor construction; Figure No. R-601.2 (Repealed)**

Sec. 54. *(Repealed by Fire Prevention and Building Safety Commission; filed Aug 27, 1990, 3:20 p.m.: 14 IR 134, eff Nov 1, 1990)*

**675 IAC 14-2.1-55 Framing details (Repealed)**

Sec. 55. *(Repealed by Fire Prevention and Building Safety Commission; filed Aug 27, 1990, 3:20 p.m.: 14 IR 134, eff Nov 1, 1990)*

**675 IAC 14-2.1-56 Allowable spans (Repealed)**

Sec. 56. *(Repealed by Fire Prevention and Building Safety Commission; filed Aug 27, 1990, 3:20 p.m.: 14 IR 134, eff Nov 1, 1990)*

**675 IAC 14-2.1-57 Bearing (Repealed)**

Sec. 57. *(Repealed by Fire Prevention and Building Safety Commission; filed Aug 27, 1990, 3:20 p.m.: 14 IR 134, eff Nov 1, 1990)*

**675 IAC 14-2.1-58 Attic ventilation (Repealed)**

Sec. 58. *(Repealed by Fire Prevention and Building Safety Commission; filed Aug 27, 1990, 3:20 p.m.: 14 IR 134, eff Nov 1, 1990)*

**675 IAC 14-2.1-59 Attic access (Repealed)**

Sec. 59. *(Repealed by Fire Prevention and Building Safety Commission; filed Aug 27, 1990, 3:20 p.m.: 14 IR 134, eff Nov 1, 1990)*

**675 IAC 14-2.1-60 Framing details; Figure No. R-702.3 (Repealed)**

Sec. 60. *(Repealed by Fire Prevention and Building Safety Commission; filed Aug 27, 1990, 3:20 p.m.: 14 IR 134, eff Nov 1, 1990)*

**675 IAC 14-2.1-61 Requirements (Repealed)**

Sec. 61. *(Repealed by Fire Prevention and Building Safety Commission; filed Aug 27, 1990, 3:20 p.m.: 14 IR 134, eff Nov 1, 1990)*

**675 IAC 14-2.1-62 Deck preparation (Repealed)**

Sec. 62. *(Repealed by Fire Prevention and Building Safety Commission; filed Aug 27, 1990, 3:20 p.m.: 14 IR 134, eff Nov 1, 1990)*

**675 IAC 14-2.1-63 Composition shingles (Repealed)**

Sec. 63. *(Repealed by Fire Prevention and Building Safety Commission; filed Aug 27, 1990, 3:20 p.m.: 14 IR 134, eff Nov 1, 1990)*

**675 IAC 14-2.1-64 General (Repealed)**

Sec. 64. *(Repealed by Fire Prevention and Building Safety Commission; filed Aug 27, 1990, 3:20 p.m.: 14 IR 134, eff Nov 1, 1990)*

**675 IAC 14-2.1-65 Slopes less than four inches (4") in twelve inches (12") but not less than two inches (2") in twelve inches (12") (Repealed)**

Sec. 65. *(Repealed by Fire Prevention and Building Safety Commission; filed Aug 27, 1990, 3:20 p.m.: 14 IR 134, eff Nov 1, 1990)*

**675 IAC 14-2.1-66 Fasteners (Repealed)**

Sec. 66. *(Repealed by Fire Prevention and Building Safety Commission; filed Aug 27, 1990, 3:20 p.m.: 14 IR 134, eff Nov 1, 1990)*

**675 IAC 14-2.1-67 Valley flashing (Repealed)**

Sec. 67. *(Repealed by Fire Prevention and Building Safety Commission; filed Aug 27, 1990, 3:20 p.m.: 14 IR 134, eff Nov 1, 1990)*

**675 IAC 14-2.1-68 Wall flashing (Repealed)**

Sec. 68. *(Repealed by Fire Prevention and Building Safety Commission; filed Aug 27, 1990, 3:20 p.m.: 14 IR 134, eff Nov 1, 1990)*

**675 IAC 14-2.1-69 Other flashing (Repealed)**

Sec. 69. *(Repealed by Fire Prevention and Building Safety Commission; filed Aug 27, 1990, 3:20 p.m.: 14 IR 134, eff Nov 1, 1990)*

**675 IAC 14-2.1-70 Hips and ridges (Repealed)**

Sec. 70. *(Repealed by Fire Prevention and Building Safety Commission; filed Aug 27, 1990, 3:20 p.m.: 14 IR 134, eff Nov 1, 1990)*

**675 IAC 14-2.1-71 Built-up roofing (Repealed)**

Sec. 71. *(Repealed by Fire Prevention and Building Safety Commission; filed Aug 27, 1990, 3:20 p.m.: 14 IR 134, eff Nov 1, 1990)*

**675 IAC 14-2.1-72 Roof coverings; Table No. R-801.2 (Repealed)**

Sec. 72. *(Repealed by Fire Prevention and Building Safety Commission; filed Aug 27, 1990, 3:20 p.m.: 14 IR 134, eff Nov 1, 1990)*

**675 IAC 14-2.1-73 Support (Repealed)**

Sec. 73. *(Repealed by Fire Prevention and Building Safety Commission; filed Aug 27, 1990, 3:20 p.m.: 14 IR 134, eff Nov 1, 1990)*

**675 IAC 14-2.1-73.1 Flue lining (Repealed)**

Sec. 73.1. *(Repealed by Fire Prevention and Building Safety Commission; filed Aug 27, 1990, 3:20 p.m.: 14 IR 134, eff Nov 1, 1990)*

**675 IAC 14-2.1-74 Flue area (Repealed)**

Sec. 74. *(Repealed by Fire Prevention and Building Safety Commission; filed Aug 27, 1990, 3:20 p.m.: 14 IR 134, eff Nov 1, 1990)*

**675 IAC 14-2.1-75 Fireplace support (Repealed)**

Sec. 75. *(Repealed by Fire Prevention and Building Safety Commission; filed Aug 27, 1990, 3:20 p.m.: 14 IR 134, eff Nov 1, 1990)*

**675 IAC 14-2.1-76 Fireplace and chimney details; Figure No. R-904 (Repealed)**

Sec. 76. *(Repealed by Fire Prevention and Building Safety Commission; filed Aug 27, 1990, 3:20 p.m.: 14 IR 134, eff Nov 1, 1990)*

**675 IAC 14-2.1-77 Installation (Repealed)**

Sec. 77. *(Repealed by Fire Prevention and Building Safety Commission; filed Aug 27, 1990, 3:20 p.m.: 14 IR 134, eff Nov 1, 1990)*

**675 IAC 14-2.1-78 Definitions (Repealed)**

Sec. 78. *(Repealed by Fire Prevention and Building Safety Commission; filed Aug 27, 1990, 3:20 p.m.: 14 IR 134, eff Nov 1, 1990)*

**675 IAC 14-2.1-79 General (Repealed)**

Sec. 79. *(Repealed by Fire Prevention and Building Safety Commission; filed Aug 27, 1990, 3:20 p.m.: 14 IR 134, eff Nov 1, 1990)*

**675 IAC 14-2.1-80 Type of fuel; fuel connection (Repealed)**

Sec. 80. *(Repealed by Fire Prevention and Building Safety Commission; filed Aug 27, 1990, 3:20 p.m.: 14 IR 134, eff Nov 1, 1990)*



1990)

**675 IAC 14-2.1-81 Fuel-burning appliance labeling (Repealed)**

Sec. 81. *(Repealed by Fire Prevention and Building Safety Commission; filed Aug 27, 1990, 3:20 p.m.: 14 IR 134, eff Nov 1, 1990)*

**675 IAC 14-2.1-82 Appliance (Repealed)**

Sec. 82. *(Repealed by Fire Prevention and Building Safety Commission; filed Aug 27, 1990, 3:20 p.m.: 14 IR 134, eff Nov 1, 1990)*

**675 IAC 14-2.1-83 General air supply (Repealed)**

Sec. 83. *(Repealed by Fire Prevention and Building Safety Commission; filed Aug 27, 1990, 3:20 p.m.: 14 IR 134, eff Nov 1, 1990)*

**675 IAC 14-2.1-84 Existing buildings (Repealed)**

Sec. 84. *(Repealed by Fire Prevention and Building Safety Commission; filed Aug 27, 1990, 3:20 p.m.: 14 IR 134, eff Nov 1, 1990)*

**675 IAC 14-2.1-85 Prohibited sources (Repealed)**

Sec. 85. *(Repealed by Fire Prevention and Building Safety Commission; filed Aug 27, 1990, 3:20 p.m.: 14 IR 134, eff Nov 1, 1990)*

**675 IAC 14-2.1-86 Interior spaces (Repealed)**

Sec. 86. *(Repealed by Fire Prevention and Building Safety Commission; filed Aug 27, 1990, 3:20 p.m.: 14 IR 134, eff Nov 1, 1990)*

**675 IAC 14-2.1-87 Attic combustion air (Repealed)**

Sec. 87. *(Repealed by Fire Prevention and Building Safety Commission; filed Aug 27, 1990, 3:20 p.m.: 14 IR 134, eff Nov 1, 1990)*

**675 IAC 14-2.1-88 Combustion air (Repealed)**

Sec. 88. *(Repealed by Fire Prevention and Building Safety Commission; filed Aug 27, 1990, 3:20 p.m.: 14 IR 134, eff Nov 1, 1990)*

**675 IAC 14-2.1-89 Ducts (Repealed)**

Sec. 89. *(Repealed by Fire Prevention and Building Safety Commission; filed Aug 27, 1990, 3:20 p.m.: 14 IR 134, eff Nov 1, 1990)*

**675 IAC 14-2.1-90 Area of combustion air openings (Repealed)**

Sec. 90. *(Repealed by Fire Prevention and Building Safety Commission; filed Aug 27, 1990, 3:20 p.m.: 14 IR 134, eff Nov 1, 1990)*

**675 IAC 14-2.1-91 Cold climate (Repealed)**

Sec. 91. *(Repealed by Fire Prevention and Building Safety Commission; filed Aug 27, 1990, 3:20 p.m.: 14 IR 134, eff Nov 1, 1990)*

**675 IAC 14-2.1-92 Appliance room combustion air requirements in cold climates; Table No. M-1211 (Repealed)**

Sec. 92. *(Repealed by Fire Prevention and Building Safety Commission; filed Aug 27, 1990, 3:20 p.m.: 14 IR 134, eff Nov 1, 1990)*

**675 IAC 14-2.1-93 Existing furnaces (Repealed)**

Sec. 93. *(Repealed by Fire Prevention and Building Safety Commission; filed Aug 27, 1990, 3:20 p.m.: 14 IR 134, eff Nov 1, 1990)*

**675 IAC 14-2.1-94 Prohibited location (Repealed)**

Sec. 94. *(Repealed by Fire Prevention and Building Safety Commission; filed Aug 27, 1990, 3:20 p.m.: 14 IR 134, eff Nov 1, 1990)*

**675 IAC 14-2.1-95 General (Repealed)**

Sec. 95. *(Repealed by Fire Prevention and Building Safety Commission; filed Aug 27, 1990, 3:20 p.m.: 14 IR 134, eff Nov 1, 1990)*

**675 IAC 14-2.1-96 General (Repealed)**

Sec. 96. *(Repealed by Fire Prevention and Building Safety Commission; filed Aug 27, 1990, 3:20 p.m.: 14 IR 134, eff Nov 1, 1990)*

**675 IAC 14-2.1-97 Circulating air supply—prohibited source (Repealed)**

Sec. 97. *(Repealed by Fire Prevention and Building Safety Commission; filed Aug 27, 1990, 3:20 p.m.: 14 IR 134, eff Nov 1, 1990)*

**675 IAC 14-2.1-98 General (Repealed)**

Sec. 98. *(Repealed by Fire Prevention and Building Safety Commission; filed Aug 27, 1990, 3:20 p.m.: 14 IR 134, eff Nov 1, 1990)*

**675 IAC 14-2.1-99 Floor furnaces (Repealed)**

Sec. 99. *(Repealed by Fire Prevention and Building Safety Commission; filed Aug 27, 1990, 3:20 p.m.: 14 IR 134, eff Nov 1, 1990)*

**675 IAC 14-2.1-100 Floor furnace access (Repealed)**

Sec. 100. *(Repealed by Fire Prevention and Building Safety Commission; filed Aug 27, 1990, 3:20 p.m.: 14 IR 134, eff Nov 1, 1990)*

**675 IAC 14-2.1-101 Floor furnace installation (Repealed)**

Sec. 101. *(Repealed by Fire Prevention and Building Safety Commission; filed Aug 27, 1990, 3:20 p.m.: 14 IR 134, eff Nov 1, 1990)*

**675 IAC 14-2.1-102 General (Repealed)**

Sec. 102. *(Repealed by Fire Prevention and Building Safety Commission; filed Aug 27, 1990, 3:20 p.m.: 14 IR 134, eff Nov 1, 1990)*

**675 IAC 14-2.1-103 Installation requirements (Repealed)**

Sec. 103. *(Repealed by Fire Prevention and Building Safety Commission; filed Aug 27, 1990, 3:20 p.m.: 14 IR 134, eff Nov 1, 1990)*

**675 IAC 14-2.1-104 Access (Repealed)**

Sec. 104. *(Repealed by Fire Prevention and Building Safety Commission; filed Aug 27, 1990, 3:20 p.m.: 14 IR 134, eff Nov 1, 1990)*

**675 IAC 14-2.1-105 Joints and seams of ducts (Repealed)**

Sec. 105. *(Repealed by Fire Prevention and Building Safety Commission; filed Aug 27, 1990, 3:20 p.m.: 14 IR 134, eff Nov 1, 1990)*

**675 IAC 14-2.1-106 Installation (Repealed)**

Sec. 106. *(Repealed by Fire Prevention and Building Safety Commission; filed Aug 27, 1990, 3:20 p.m.: 14 IR 134, eff Nov 1, 1990)*

**675 IAC 14-2.1-107 Installation (Repealed)**

Sec. 107. *(Repealed by Fire Prevention and Building Safety Commission; filed Aug 27, 1990, 3:20 p.m.: 14 IR 134, eff Nov 1, 1990)*

**675 IAC 14-2.1-108 Underfloor plenum; single dwelling (Repealed)**

Sec. 108. *(Repealed by Fire Prevention and Building Safety Commission; filed Aug 27, 1990, 3:20 p.m.: 14 IR 134, eff Nov 1, 1990)*

**675 IAC 14-2.1-109 Ventilation systems (Repealed)**

Sec. 109. *(Repealed by Fire Prevention and Building Safety Commission; filed Aug 27, 1990, 3:20 p.m.: 14 IR 134, eff Nov 1, 1990)*

**675 IAC 14-2.1-110 Condensate disposal (Repealed)**

Sec. 110. *(Repealed by Fire Prevention and Building Safety Commission; filed Aug 27, 1990, 3:20 p.m.: 14 IR 134, eff Nov 1, 1990)*

**675 IAC 14-2.1-111 Identification (Repealed)**

Sec. 111. *(Repealed by Fire Prevention and Building Safety Commission; filed Aug 27, 1990, 3:20 p.m.: 14 IR 134, eff Nov 1, 1990)*

1, 1990)

**675 IAC 14-2.1-112 Containers above ground (Repealed)**

Sec. 112. *(Repealed by Fire Prevention and Building Safety Commission; filed Aug 27, 1990, 3:20 p.m.: 14 IR 134, eff Nov 1, 1990)*

**675 IAC 14-2.1-113 Containers below ground (Repealed)**

Sec. 113. *(Repealed by Fire Prevention and Building Safety Commission; filed Aug 27, 1990, 3:20 p.m.: 14 IR 134, eff Nov 1, 1990)*

**675 IAC 14-2.1-114 Pipe size (Repealed)**

Sec. 114. *(Repealed by Fire Prevention and Building Safety Commission; filed Aug 27, 1990, 3:20 p.m.: 14 IR 134, eff Nov 1, 1990)*

**675 IAC 14-2.1-115 Shutoff valves (Repealed)**

Sec. 115. *(Repealed by Fire Prevention and Building Safety Commission; filed Aug 27, 1990, 3:20 p.m.: 14 IR 134, eff Nov 1, 1990)*

**675 IAC 14-2.1-116 Appliance connectors (Repealed)**

Sec. 116. *(Repealed by Fire Prevention and Building Safety Commission; filed Aug 27, 1990, 3:20 p.m.: 14 IR 134, eff Nov 1, 1990)*

**675 IAC 14-2.1-117 Oil fuel supply (Repealed)**

Sec. 117. *(Repealed by Fire Prevention and Building Safety Commission; filed Aug 27, 1990, 3:20 p.m.: 14 IR 134, eff Nov 1, 1990)*

**675 IAC 14-2.1-118 Application (Repealed)**

Sec. 118. *(Repealed by Fire Prevention and Building Safety Commission; filed Aug 27, 1990, 3:20 p.m.: 14 IR 134, eff Nov 1, 1990)*

**675 IAC 14-2.1-119 Studs in nonbearing partitions (Repealed)**

Sec. 119. *(Repealed by Fire Prevention and Building Safety Commission; filed Aug 27, 1990, 3:20 p.m.: 14 IR 134, eff Nov 1, 1990)*

**675 IAC 14-2.1-120 Definitions (Repealed)**

Sec. 120. *(Repealed by Fire Prevention and Building Safety Commission; filed Aug 27, 1990, 3:20 p.m.: 14 IR 134, eff Nov 1, 1990)*

**675 IAC 14-2.1-120.5 Building sewers (Repealed)**

Sec. 120.5. *(Repealed by Fire Prevention and Building Safety Commission; filed Aug 27, 1990, 3:20 p.m.: 14 IR 134, eff Nov 1, 1990)*

**675 IAC 14-2.1-121    Underground (Repealed)**

Sec. 121. *(Repealed by Fire Prevention and Building Safety Commission; filed Aug 27, 1990, 3:20 p.m.: 14 IR 134, eff Nov 1, 1990)*

**675 IAC 14-2.1-122    Number of fixtures per trap (Repealed)**

Sec. 122. *(Repealed by Fire Prevention and Building Safety Commission; filed Aug 27, 1990, 3:20 p.m.: 14 IR 134, eff Nov 1, 1990)*

**675 IAC 14-2.1-123    Vertical leg for waste fixture drains (Repealed)**

Sec. 123. *(Repealed by Fire Prevention and Building Safety Commission; filed Aug 27, 1990, 3:20 p.m.: 14 IR 134, eff Nov 1, 1990)*

**675 IAC 14-2.1-124    Dry vent sizing (Repealed)**

Sec. 124. *(Repealed by Fire Prevention and Building Safety Commission; filed Aug 27, 1990, 3:20 p.m.: 14 IR 134, eff Nov 1, 1990)*

**675 IAC 14-2.1-125    Typical single bath wet-vent arrangements; Figure No. P-2207.7.2 (Repealed)**

Sec. 125. *(Repealed by Fire Prevention and Building Safety Commission; filed Aug 27, 1990, 3:20 p.m.: 14 IR 134, eff Nov 1, 1990)*

**675 IAC 14-2.1-126    Typical double-bath wet-vent arrangements; Figure No. P-2207.7.3 (Repealed)**

Sec. 126. *(Repealed by Fire Prevention and Building Safety Commission; filed Aug 27, 1990, 3:20 p.m.: 14 IR 134, eff Nov 1, 1990)*

**675 IAC 14-2.1-127    Wastestack serving as wet-vent for laundry group; Figure No. P-2207.7.5 (Repealed)**

Sec. 127. *(Repealed by Fire Prevention and Building Safety Commission; filed Aug 27, 1990, 3:20 p.m.: 14 IR 134, eff Nov 1, 1990)*

**675 IAC 14-2.1-128    Typical methods of connecting fixture drains to stack-vented systems; Figure No. P-2207.8.2 (Repealed)**

Sec. 128. *(Repealed by Fire Prevention and Building Safety Commission; filed Aug 27, 1990, 3:20 p.m.: 14 IR 134, eff Nov 1, 1990)*

**675 IAC 14-2.1-129    Typical single-stack system for a two-story dwelling; Figure No. P-2207.8.3 (Repealed)**

Sec. 129. *(Repealed by Fire Prevention and Building Safety Commission; filed Aug 27, 1990, 3:20 p.m.: 14 IR 134, eff Nov 1, 1990)*

**675 IAC 14-2.1-130    Typical uniformly sized horizontal branch system; Figure No. P-2207.9-A (Repealed)**

Sec. 130. *(Repealed by Fire Prevention and Building Safety Commission; filed Aug 27, 1990, 3:20 p.m.: 14 IR 134, eff Nov 1, 1990)*

**675 IAC 14-2.1-131 Typical horizontal branch system reducing in size utilizing wet venting; Figure No. P-2207.9-B (Repealed)**

Sec. 131. *(Repealed by Fire Prevention and Building Safety Commission; filed Aug 27, 1990, 3:20 p.m.: 14 IR 134, eff Nov 1, 1990)*

**675 IAC 14-2.1-132 Access to connections (Repealed)**

Sec. 132. *(Repealed by Fire Prevention and Building Safety Commission; filed Aug 27, 1990, 3:20 p.m.: 14 IR 134, eff Nov 1, 1990)*

**675 IAC 14-2.1-133 Seals (Repealed)**

Sec. 133. *(Repealed by Fire Prevention and Building Safety Commission; filed Aug 27, 1990, 3:20 p.m.: 14 IR 134, eff Nov 1, 1990)*

**675 IAC 14-2.1-134 Length of trap arm (Repealed)**

Sec. 134. *(Repealed by Fire Prevention and Building Safety Commission; filed Aug 27, 1990, 3:20 p.m.: 14 IR 134, eff Nov 1, 1990)*

**675 IAC 14-2.1-135 Showers (Repealed)**

Sec. 135. *(Repealed by Fire Prevention and Building Safety Commission; filed Aug 27, 1990, 3:20 p.m.: 14 IR 134, eff Nov 1, 1990)*

**675 IAC 14-2.1-136 General (Repealed)**

Sec. 136. *(Repealed by Fire Prevention and Building Safety Commission; filed Aug 27, 1990, 3:20 p.m.: 14 IR 134, eff Nov 1, 1990)*

**675 IAC 14-2.1-137 Water-supply riser (Repealed)**

Sec. 137. *(Repealed by Fire Prevention and Building Safety Commission; filed Aug 27, 1990, 3:20 p.m.: 14 IR 134, eff Nov 1, 1990)*

**675 IAC 14-2.1-138 Shower heads (Repealed)**

Sec. 138. *(Repealed by Fire Prevention and Building Safety Commission; filed Aug 27, 1990, 3:20 p.m.: 14 IR 134, eff Nov 1, 1990)*

**675 IAC 14-2.1-139 Clothes washer (Repealed)**

Sec. 139. *(Repealed by Fire Prevention and Building Safety Commission; filed Aug 27, 1990, 3:20 p.m.: 14 IR 134, eff Nov 1, 1990)*

**675 IAC 14-2.1-140 Materials (Repealed)**

Sec. 140. *(Repealed by Fire Prevention and Building Safety Commission; filed Aug 27, 1990, 3:20 p.m.: 14 IR 134, eff Nov 1, 1990)*

**675 IAC 14-2.1-141 Soldered joints (Repealed)**

Sec. 141. *(Repealed by Fire Prevention and Building Safety Commission; filed Aug 27, 1990, 3:20 p.m.: 14 IR 134, eff Nov 1, 1990)*

**675 IAC 14-2.1-142 General (Repealed)**

Sec. 142. *(Repealed by Fire Prevention and Building Safety Commission; filed Aug 27, 1990, 3:20 p.m.: 14 IR 134, eff Nov 1, 1990)*

**675 IAC 14-2.1-143 Minimum sizes of fixture branches (Repealed)**

Sec. 143. *(Repealed by Fire Prevention and Building Safety Commission; filed Aug 27, 1990, 3:20 p.m.: 14 IR 134, eff Nov 1, 1990)*

**675 IAC 14-2.1-144 Chapter 25; sewers and private or individual sewage disposal systems (Repealed)**

Sec. 144. *(Repealed by Fire Prevention and Building Safety Commission; filed Aug 27, 1990, 3:20 p.m.: 14 IR 134, eff Nov 1, 1990)*

**675 IAC 14-2.1-145 General (Repealed)**

Sec. 145. *(Repealed by Fire Prevention and Building Safety Commission; filed Aug 27, 1990, 3:20 p.m.: 14 IR 134, eff Nov 1, 1990)*

**675 IAC 14-2.1-146 Building sewer materials (Repealed)**

Sec. 146. *(Repealed by Fire Prevention and Building Safety Commission; filed Aug 27, 1990, 3:20 p.m.: 14 IR 134, eff Nov 1, 1990)*

**675 IAC 14-2.1-147 Markings (Repealed)**

Sec. 147. *(Repealed by Fire Prevention and Building Safety Commission; filed Aug 27, 1990, 3:20 p.m.: 14 IR 134, eff Nov 1, 1990)*

**675 IAC 14-2.1-148 Size (Repealed)**

Sec. 148. *(Repealed by Fire Prevention and Building Safety Commission; filed Aug 27, 1990, 3:20 p.m.: 14 IR 134, eff Nov 1, 1990)*

**675 IAC 14-2.1-149 Grade, support (Repealed)**

Sec. 149. *(Repealed by Fire Prevention and Building Safety Commission; filed Aug 27, 1990, 3:20 p.m.: 14 IR 134, eff Nov 1, 1990)*

**675 IAC 14-2.1-150 Cleanouts (Repealed)**

Sec. 150. *(Repealed by Fire Prevention and Building Safety Commission; filed Aug 27, 1990, 3:20 p.m.: 14 IR 134, eff Nov 1, 1990)*

**675 IAC 14-2.1-151 Sewer, water pipes (Repealed)**

Sec. 151. *(Repealed by Fire Prevention and Building Safety Commission; filed Aug 27, 1990, 3:20 p.m.: 14 IR 134, eff Nov 1, 1990)*

**675 IAC 14-2.1-152 Drawing; specifications (Repealed)**

Sec. 152. *(Repealed by Fire Prevention and Building Safety Commission; filed Aug 27, 1990, 3:20 p.m.: 14 IR 134, eff Nov 1, 1990)*

**675 IAC 14-2.1-153 Location (Repealed)**

Sec. 153. *(Repealed by Fire Prevention and Building Safety Commission; filed Aug 27, 1990, 3:20 p.m.: 14 IR 134, eff Nov 1, 1990)*

**675 IAC 14-2.1-154 Abandoned sewers; sewage disposal facilities (Repealed)**

Sec. 154. *(Repealed by Fire Prevention and Building Safety Commission; filed Aug 27, 1990, 3:20 p.m.: 14 IR 134, eff Nov 1, 1990)*

**675 IAC 14-2.1-155 Electrical; energy conservation (Repealed)**

Sec. 155. *(Repealed by Fire Prevention and Building Safety Commission; filed Aug 27, 1990, 3:20 p.m.: 14 IR 134, eff Nov 1, 1990)*

**675 IAC 14-2.1-156 Abbreviations (Repealed)**

Sec. 156. *(Repealed by Fire Prevention and Building Safety Commission; filed Aug 27, 1990, 3:20 p.m.: 14 IR 134, eff Nov 1, 1990)*

**675 IAC 14-2.1-157 Flame-retardant treated wood (Repealed)**

Sec. 157. *(Repealed by Fire Prevention and Building Safety Commission; filed Aug 27, 1990, 3:20 p.m.: 14 IR 134, eff Nov 1, 1990)*

**675 IAC 14-2.1-158 Foundations (Repealed)**

Sec. 158. *(Repealed by Fire Prevention and Building Safety Commission; filed Aug 27, 1990, 3:20 p.m.: 14 IR 134, eff Nov 1, 1990)*

**675 IAC 14-2.1-159 Slabs (Repealed)**

Sec. 159. *(Repealed by Fire Prevention and Building Safety Commission; filed Aug 27, 1990, 3:20 p.m.: 14 IR 134, eff Nov 1, 1990)*

**675 IAC 14-2.1-160 Wall construction (Repealed)**

Sec. 160. *(Repealed by Fire Prevention and Building Safety Commission; filed Aug 27, 1990, 3:20 p.m.: 14 IR 134, eff Nov 1, 1990)*

**675 IAC 14-2.1-161 Wall covering (Repealed)**

Sec. 161. *(Repealed by Fire Prevention and Building Safety Commission; filed Aug 27, 1990, 3:20 p.m.: 14 IR 134, eff Nov 1, 1990)*



1, 1990)

**675 IAC 14-2.1-162 Roof covering (Repealed)**

Sec. 162. *(Repealed by Fire Prevention and Building Safety Commission; filed Aug 27, 1990, 3:20 p.m.: 14 IR 134, eff Nov 1, 1990)*

**675 IAC 14-2.1-163 Mechanical materials (Repealed)**

Sec. 163. *(Repealed by Fire Prevention and Building Safety Commission; filed Aug 27, 1990, 3:20 p.m.: 14 IR 134, eff Nov 1, 1990)*

**675 IAC 14-2.1-164 Mechanical equipment (Repealed)**

Sec. 164. *(Repealed by Fire Prevention and Building Safety Commission; filed Aug 27, 1990, 3:20 p.m.: 14 IR 134, eff Nov 1, 1990)*

**675 IAC 14-2.1-165 Plumbing; general (Repealed)**

Sec. 165. *(Repealed by Fire Prevention and Building Safety Commission; filed Aug 27, 1990, 3:20 p.m.: 14 IR 134, eff Nov 1, 1990)*

**675 IAC 14-2.1-166 Sewer pipe (Repealed)**

Sec. 166. *(Repealed by Fire Prevention and Building Safety Commission; filed Aug 27, 1990, 3:20 p.m.: 14 IR 134, eff Nov 1, 1990)*

**675 IAC 14-2.1-167 Water piping (Repealed)**

Sec. 167. *(Repealed by Fire Prevention and Building Safety Commission; filed Aug 27, 1990, 3:20 p.m.: 14 IR 134, eff Nov 1, 1990)*

**675 IAC 14-2.1-168 Appendix A (Repealed)**

Sec. 168. *(Repealed by Fire Prevention and Building Safety Commission; filed Aug 27, 1990, 3:20 p.m.: 14 IR 134, eff Nov 1, 1990)*

**675 IAC 14-2.1-169 Appendix B (Repealed)**

Sec. 169. *(Repealed by Fire Prevention and Building Safety Commission; filed Aug 27, 1990, 3:20 p.m.: 14 IR 134, eff Nov 1, 1990)*

**675 IAC 14-2.1-170 Appendix C (Repealed)**

Sec. 170. *(Repealed by Fire Prevention and Building Safety Commission; filed Aug 27, 1990, 3:20 p.m.: 14 IR 134, eff Nov 1, 1990)*

**675 IAC 14-2.1-171 Structural independence (Repealed)**

Sec. 171. *(Repealed by Fire Prevention and Building Safety Commission; filed Aug 27, 1990, 3:20 p.m.: 14 IR 134, eff Nov 1, 1990)*

**675 IAC 14-2.1-172 Exterior walls (Repealed)**

Sec. 172. *(Repealed by Fire Prevention and Building Safety Commission; filed Aug 27, 1990, 3:20 p.m.: 14 IR 134, eff Nov 1, 1990)*

**675 IAC 14-2.1-173 Openings (Repealed)**

Sec. 173. *(Repealed by Fire Prevention and Building Safety Commission; filed Aug 27, 1990, 3:20 p.m.: 14 IR 134, eff Nov 1, 1990)*

**Rule 3. Permanent Installation of Manufactured Homes (Repealed)**

*(Repealed by Fire Prevention and Building Safety Commission; filed Aug 27, 1990, 3:20 p.m.: 14 IR 134, eff Nov 1, 1990)*

**Rule 4. Indiana One and Two Family Dwelling Code, 1990 Edition (Repealed)**

*(Repealed by Fire Prevention and Building Safety Commission; filed Oct 30, 1997, 12:45 p.m.: 21 IR 1003)*

**Rule 4.1. Indiana One and Two Family Dwelling Code, 1997 Edition (Repealed)**

*(Repealed by Fire Prevention and Building Safety Commission; filed May 23, 2001, 4:02 p.m.: 24 IR 3066)*

**Rule 4.2. Indiana Residential Code**

**675 IAC 14-4.2-1 Adoption by reference; title; availability; purpose (Repealed)**

Sec. 1. *(Repealed by Fire Prevention and Building Safety Commission; filed Jun 13, 2005, 3:00 p.m.: 28 IR 3304, eff 90 days after filing with the Secretary of State)*

**675 IAC 14-4.2-2 Chapter 1; administration (Repealed)**

Sec. 2. *(Repealed by Fire Prevention and Building Safety Commission; filed Jun 13, 2005, 3:00 p.m.: 28 IR 3304, eff 90 days after filing with the Secretary of State)*

**675 IAC 14-4.2-3 Section R202; definitions (Repealed)**

Sec. 3. *(Repealed by Fire Prevention and Building Safety Commission; filed Jun 13, 2005, 3:00 p.m.: 28 IR 3304, eff 90 days after filing with the Secretary of State)*

**675 IAC 14-4.2-4 Section R301.2; climatic and geographic design criteria (Repealed)**

Sec. 4. *(Repealed by Fire Prevention and Building Safety Commission; filed Jun 13, 2005, 3:00 p.m.: 28 IR 3304, eff 90 days after filing with the Secretary of State)*

**675 IAC 14-4.2-5 Sections R301.2.1.1 and R301.2.1.2; design criteria, internal pressure (Repealed)**

Sec. 5. *(Repealed by Fire Prevention and Building Safety Commission; filed Jun 13, 2005, 3:00 p.m.: 28 IR 3304, eff 90 days after filing with the Secretary of State)*

**675 IAC 14-4.2-6 Table R301.2(1); climatic and geographical design criteria (Repealed)**

Sec. 6. *(Repealed by Fire Prevention and Building Safety Commission; filed Jun 13, 2005, 3:00 p.m.: 28 IR 3304, eff 90 days after filing with the Secretary of State)*

**675 IAC 14-4.2-7      Figures R301.2(1), R301.2(2), R301.2(3), R301.2(4), R301.2(5), R301.2(6), and R301.2(7)  
(Repealed)**

Sec. 7. *(Repealed by Fire Prevention and Building Safety Commission; filed Jun 13, 2005, 3:00 p.m.: 28 IR 3304, eff 90 days after filing with the Secretary of State)*

**675 IAC 14-4.2-8      Table R301.2.1.2 (Repealed)**

Sec. 8. *(Repealed by Fire Prevention and Building Safety Commission; filed Jun 13, 2005, 3:00 p.m.: 28 IR 3304, eff 90 days after filing with the Secretary of State)*

**675 IAC 14-4.2-9      Section R301.2.2; seismic provisions (Repealed)**

Sec. 9. *(Repealed by Fire Prevention and Building Safety Commission; filed Jun 13, 2005, 3:00 p.m.: 28 IR 3304, eff 90 days after filing with the Secretary of State)*

**675 IAC 14-4.2-10     Section R301.2.2.1; determination of seismic design category (Repealed)**

Sec. 10. *(Repealed by Fire Prevention and Building Safety Commission; filed Jun 13, 2005, 3:00 p.m.: 28 IR 3304, eff 90 days after filing with the Secretary of State)*

**675 IAC 14-4.2-11     Section R301.2.2.1.1; alternate determination of seismic design category (Repealed)**

Sec. 11. *(Repealed by Fire Prevention and Building Safety Commission; filed Jun 13, 2005, 3:00 p.m.: 28 IR 3304, eff 90 days after filing with the Secretary of State)*

**675 IAC 14-4.2-12     Section R301.2.2.1.2; alternative determination of seismic design category E (Repealed)**

Sec. 12. *(Repealed by Fire Prevention and Building Safety Commission; filed Jun 13, 2005, 3:00 p.m.: 28 IR 3304, eff 90 days after filing with the Secretary of State)*

**675 IAC 14-4.2-13     Section R301.2.2.2; determination of seismic design category (Repealed)**

Sec. 13. *(Repealed by Fire Prevention and Building Safety Commission; filed Jun 13, 2005, 3:00 p.m.: 28 IR 3304, eff 90 days after filing with the Secretary of State)*

**675 IAC 14-4.2-13.5   Section R301.2.2.3; anchored stone and masonry veneer in seismic design Categories C and C<sub>1</sub>  
(Repealed)**

Sec. 13.5. *(Repealed by Fire Prevention and Building Safety Commission; filed Jun 13, 2005, 3:00 p.m.: 28 IR 3304, eff 90 days after filing with the Secretary of State)*

**675 IAC 14-4.2-14     Section R301.2.2.9; irregular buildings in seismic design categories D<sub>1</sub> and D<sub>2</sub> (Repealed)**

Sec. 14. *(Repealed by Fire Prevention and Building Safety Commission; filed Jun 13, 2005, 3:00 p.m.: 28 IR 3304, eff 90 days after filing with the Secretary of State)*

**675 IAC 14-4.2-15     Section R301.2.4; floodplain construction (Repealed)**

Sec. 15. *(Repealed by Fire Prevention and Building Safety Commission; filed Jun 13, 2005, 3:00 p.m.: 28 IR 3304, eff 90 days after filing with the Secretary of State)*

**675 IAC 14-4.2-15.5 Section R301.4; live load (Repealed)**

Sec. 15.5. *(Repealed by Fire Prevention and Building Safety Commission; filed Jun 13, 2005, 3:00 p.m.: 28 IR 3304, eff 90 days after filing with the Secretary of State)*

**675 IAC 14-4.2-16 Table R301.4; minimum uniformly distributed live loads (Repealed)**

Sec. 16. *(Repealed by Fire Prevention and Building Safety Commission; filed Jun 13, 2005, 3:00 p.m.: 28 IR 3304, eff 90 days after filing with the Secretary of State)*

**675 IAC 14-4.2-17 Section R302.1; exterior walls (Repealed)**

Sec. 17. *(Repealed by Fire Prevention and Building Safety Commission; filed Jun 13, 2005, 3:00 p.m.: 28 IR 3304, eff 90 days after filing with the Secretary of State)*

**675 IAC 14-4.2-18 Section R302.2; openings (Repealed)**

Sec. 18. *(Repealed by Fire Prevention and Building Safety Commission; filed Jun 13, 2005, 3:00 p.m.: 28 IR 3304, eff 90 days after filing with the Secretary of State)*

**675 IAC 14-4.2-19 Section R303.1; habitable rooms (Repealed)**

Sec. 19. *(Repealed by Fire Prevention and Building Safety Commission; filed Jun 13, 2005, 3:00 p.m.: 28 IR 3304, eff 90 days after filing with the Secretary of State)*

**675 IAC 14-4.2-19.5 Section R303.4; stairway illumination (Repealed)**

Sec. 19.5. *(Repealed by Fire Prevention and Building Safety Commission; filed Jun 13, 2005, 3:00 p.m.: 28 IR 3304, eff 90 days after filing with the Secretary of State)*

**675 IAC 14-4.2-20 Section R305.1; minimum height (Repealed)**

Sec. 20. *(Repealed by Fire Prevention and Building Safety Commission; filed Jun 13, 2005, 3:00 p.m.: 28 IR 3304, eff 90 days after filing with the Secretary of State)*

**675 IAC 14-4.2-20.5 Section R308.4; hazardous locations (Repealed)**

Sec. 20.5. *(Repealed by Fire Prevention and Building Safety Commission; filed Jun 13, 2005, 3:00 p.m.: 28 IR 3304, eff 90 days after filing with the Secretary of State)*

**675 IAC 14-4.2-21 Section R309; garages and carports (Repealed)**

Sec. 21. *(Repealed by Fire Prevention and Building Safety Commission; filed Jun 13, 2005, 3:00 p.m.: 28 IR 3304, eff 90 days after filing with the Secretary of State)*

**675 IAC 14-4.2-22 Section R310; emergency escape and rescue openings (Repealed)**

Sec. 22. *(Repealed by Fire Prevention and Building Safety Commission; filed Jun 13, 2005, 3:00 p.m.: 28 IR 3304, eff 90 days after filing with the Secretary of State)*

**675 IAC 14-4.2-23 Section R311.2; type of lock or latch (Repealed)**

Sec. 23. *(Repealed by Fire Prevention and Building Safety Commission; filed Jun 13, 2005, 3:00 p.m.: 28 IR 3304, eff 90 days after filing with the Secretary of State)*

**675 IAC 14-4.2-24 Section R311.5; exit facilities (Repealed)**

Sec. 24. *(Repealed by Fire Prevention and Building Safety Commission; filed Jun 13, 2005, 3:00 p.m.: 28 IR 3304, eff 90 days after filing with the Secretary of State)*

**675 IAC 14-4.2-25 Section R312.1, Section R312.1.1 and Section R312.1.2; general, landings for stairways and landings for doors (Repealed)**

Sec. 25. *(Repealed by Fire Prevention and Building Safety Commission; filed Jun 13, 2005, 3:00 p.m.: 28 IR 3304, eff 90 days after filing with the Secretary of State)*

**675 IAC 14-4.2-26 Section R314.2; treads and risers (Repealed)**

Sec. 26. *(Repealed by Fire Prevention and Building Safety Commission; filed Jun 13, 2005, 3:00 p.m.: 28 IR 3304, eff 90 days after filing with the Secretary of State)*

**675 IAC 14-4.2-26.5 Section R314.8; under-stair protection (Repealed)**

Sec. 26.5. *(Repealed by Fire Prevention and Building Safety Commission; filed Jun 13, 2005, 3:00 p.m.: 28 IR 3304, eff 90 days after filing with the Secretary of State)*

**675 IAC 14-4.2-27 Section R314.9; bulkhead enclosure stairways (Repealed)**

Sec. 27. *(Repealed by Fire Prevention and Building Safety Commission; filed Jun 13, 2005, 3:00 p.m.: 28 IR 3304, eff 90 days after filing with the Secretary of State)*

**675 IAC 14-4.2-27.5 Section R315.1; handrails (Repealed)**

Sec. 27.5. *(Repealed by Fire Prevention and Building Safety Commission; filed Jun 13, 2005, 3:00 p.m.: 28 IR 3304, eff 90 days after filing with the Secretary of State)*

**675 IAC 14-4.2-28 Section R315.2; handrail grip size (Repealed)**

Sec. 28. *(Repealed by Fire Prevention and Building Safety Commission; filed Jun 13, 2005, 3:00 p.m.: 28 IR 3304, eff 90 days after filing with the Secretary of State)*

**675 IAC 14-4.2-29 Section R316.1; guards required (Repealed)**

Sec. 29. *(Repealed by Fire Prevention and Building Safety Commission; filed Jun 13, 2005, 3:00 p.m.: 28 IR 3304, eff 90 days after filing with the Secretary of State)*

**675 IAC 14-4.2-30 Section R316.2; guard opening limitations (Repealed)**

Sec. 30. *(Repealed by Fire Prevention and Building Safety Commission; filed Jun 13, 2005, 3:00 p.m.: 28 IR 3304, eff 90 days after filing with the Secretary of State)*

**675 IAC 14-4.2-31 Section R317; smoke alarm (Repealed)**

Sec. 31. *(Repealed by Fire Prevention and Building Safety Commission; filed Jun 13, 2005, 3:00 p.m.: 28 IR 3304, eff 90 days after filing with the Secretary of State)*

**675 IAC 14-4.2-32 Section R318.2.3; attics and crawl spaces (Repealed)**

Sec. 32. *(Repealed by Fire Prevention and Building Safety Commission; filed Jun 13, 2005, 3:00 p.m.: 28 IR 3304, eff 90 days after filing with the Secretary of State)*

**675 IAC 14-4.2-33 Section R322.1; moisture control (Repealed)**

Sec. 33. *(Repealed by Fire Prevention and Building Safety Commission; filed Jun 13, 2005, 3:00 p.m.: 28 IR 3304, eff 90 days after filing with the Secretary of State)*

**675 IAC 14-4.2-34 Section R323.1; location required (Repealed)**

Sec. 34. *(Repealed by Fire Prevention and Building Safety Commission; filed Jun 13, 2005, 3:00 p.m.: 28 IR 3304, eff 90 days after filing with the Secretary of State)*

**675 IAC 14-4.2-35 Section R323.1.2; geographical areas (Repealed)**

Sec. 35. *(Repealed by Fire Prevention and Building Safety Commission; filed Jun 13, 2005, 3:00 p.m.: 28 IR 3304, eff 90 days after filing with the Secretary of State)*

**675 IAC 14-4.2-36 Section R323.1.4; wood columns (Repealed)**

Sec. 36. *(Repealed by Fire Prevention and Building Safety Commission; filed Jun 13, 2005, 3:00 p.m.: 28 IR 3304, eff 90 days after filing with the Secretary of State)*

**675 IAC 14-4.2-37 Section R323.2; quality mark (Repealed)**

Sec. 37. *(Repealed by Fire Prevention and Building Safety Commission; filed Jun 13, 2005, 3:00 p.m.: 28 IR 3304, eff 90 days after filing with the Secretary of State)*

**675 IAC 14-4.2-37.5 Section R324.1; subterranean termite control (Repealed)**

Sec. 37.5. *(Repealed by Fire Prevention and Building Safety Commission; filed Jun 13, 2005, 3:00 p.m.: 28 IR 3304, eff 90 days after filing with the Secretary of State)*

**675 IAC 14-4.2-38 Section R324.4; foam plastic protection (Repealed)**

Sec. 38. *(Repealed by Fire Prevention and Building Safety Commission; filed Jun 13, 2005, 3:00 p.m.: 28 IR 3304, eff 90 days after filing with the Secretary of State)*

**675 IAC 14-4.2-39 Section R326; accessibility (Repealed)**

Sec. 39. *(Repealed by Fire Prevention and Building Safety Commission; filed Jun 13, 2005, 3:00 p.m.: 28 IR 3304, eff 90 days after filing with the Secretary of State)*

**675 IAC 14-4.2-40 Section 327; flood-resistant construction (Repealed)**

Sec. 40. *(Repealed by Fire Prevention and Building Safety Commission; filed Jun 13, 2005, 3:00 p.m.: 28 IR 3304, eff 90 days after filing with the Secretary of State)*

*after filing with the Secretary of State)*

**675 IAC 14-4.2-41 Section 401.1; application (Repealed)**

Sec. 41. *(Repealed by Fire Prevention and Building Safety Commission; filed Jun 13, 2005, 3:00 p.m.: 28 IR 3304, eff 90 days after filing with the Secretary of State)*

**675 IAC 14-4.2-42 Section R401.3; drainage (Repealed)**

Sec. 42. *(Repealed by Fire Prevention and Building Safety Commission; filed Jun 13, 2005, 3:00 p.m.: 28 IR 3304, eff 90 days after filing with the Secretary of State)*

**675 IAC 14-4.2-43 Section R402.1.2; wood treatment (Repealed)**

Sec. 43. *(Repealed by Fire Prevention and Building Safety Commission; filed Jun 13, 2005, 3:00 p.m.: 28 IR 3304, eff 90 days after filing with the Secretary of State)*

**675 IAC 14-4.2-44 Section R403.1; general (Repealed)**

Sec. 44. *(Repealed by Fire Prevention and Building Safety Commission; filed Jun 13, 2005, 3:00 p.m.: 28 IR 3304, eff 90 days after filing with the Secretary of State)*

**675 IAC 14-4.2-45 Table R403.1; minimum width of concrete or masonry footings (Repealed)**

Sec. 45. *(Repealed by Fire Prevention and Building Safety Commission; filed Jun 13, 2005, 3:00 p.m.: 28 IR 3304, eff 90 days after filing with the Secretary of State)*

**675 IAC 14-4.2-45.3 Section R403.1.1; minimum size (Repealed)**

Sec. 45.3. *(Repealed by Fire Prevention and Building Safety Commission; filed Jun 13, 2005, 3:00 p.m.: 28 IR 3304, eff 90 days after filing with the Secretary of State)*

**675 IAC 14-4.2-45.5 Section R403.1.2; continuous footings in seismic design categories D<sub>1</sub> and D<sub>2</sub> (Repealed)**

Sec. 45.5. *(Repealed by Fire Prevention and Building Safety Commission; filed Jun 13, 2005, 3:00 p.m.: 28 IR 3304, eff 90 days after filing with the Secretary of State)*

**675 IAC 14-4.2-45.6 Section R403.1.3; seismic reinforcing (Repealed)**

Sec. 45.6. *(Repealed by Fire Prevention and Building Safety Commission; filed Jun 13, 2005, 3:00 p.m.: 28 IR 3304, eff 90 days after filing with the Secretary of State)*

**675 IAC 14-4.2-46 Section R403.1.3.1; foundations with stemwalls (Repealed)**

Sec. 46. *(Repealed by Fire Prevention and Building Safety Commission; filed Jun 13, 2005, 3:00 p.m.: 28 IR 3304, eff 90 days after filing with the Secretary of State)*

**675 IAC 14-4.2-46.5 Section R403.1.3.2; slabs-on-ground with turned-down footings (Repealed)**

Sec. 46.5. *(Repealed by Fire Prevention and Building Safety Commission; filed Jun 13, 2005, 3:00 p.m.: 28 IR 3304, eff 90 days after filing with the Secretary of State)*

**675 IAC 14-4.2-46.6 Section R403.1.4; minimum depth (Repealed)**

Sec. 46.6. *(Repealed by Fire Prevention and Building Safety Commission; filed Jun 13, 2005, 3:00 p.m.: 28 IR 3304, eff 90 days after filing with the Secretary of State)*

**675 IAC 14-4.2-46.8 Section R403.1.6; foundation anchorage (Repealed)**

Sec. 46.8. *(Repealed by Fire Prevention and Building Safety Commission; filed Jun 13, 2005, 3:00 p.m.: 28 IR 3304, eff 90 days after filing with the Secretary of State)*

**675 IAC 14-4.2-47 Section R403.1.7.3; foundation elevation (Repealed)**

Sec. 47. *(Repealed by Fire Prevention and Building Safety Commission; filed Jun 13, 2005, 3:00 p.m.: 28 IR 3304, eff 90 days after filing with the Secretary of State)*

**675 IAC 14-4.2-48 Section R403.1.7.4; alternate setback and clearances (Repealed)**

Sec. 48. *(Repealed by Fire Prevention and Building Safety Commission; filed Jun 13, 2005, 3:00 p.m.: 28 IR 3304, eff 90 days after filing with the Secretary of State)*

**675 IAC 14-4.2-49 Section R403.1.8; foundations on expansive soils (Repealed)**

Sec. 49. *(Repealed by Fire Prevention and Building Safety Commission; filed Jun 13, 2005, 3:00 p.m.: 28 IR 3304, eff 90 days after filing with the Secretary of State)*

**675 IAC 14-4.2-49.1 Section R403.1.8.1; expansive soils classifications (Repealed)**

Sec. 49.1. *(Repealed by Fire Prevention and Building Safety Commission; filed Jun 13, 2005, 3:00 p.m.: 28 IR 3304, eff 90 days after filing with the Secretary of State)*

**675 IAC 14-4.2-49.3 Table R403.2; size of footings supporting piers and columns (Repealed)**

Sec. 49.3. *(Repealed by Fire Prevention and Building Safety Commission; filed Jun 13, 2005, 3:00 p.m.: 28 IR 3304, eff 90 days after filing with the Secretary of State)*

**675 IAC 14-4.2-49.5 Figure R403.3(1); insulation placement for frost-protected footings in heated buildings (Repealed)**

Sec. 49.5. *(Repealed by Fire Prevention and Building Safety Commission; filed Jun 13, 2005, 3:00 p.m.: 28 IR 3304, eff 90 days after filing with the Secretary of State)*

**675 IAC 14-4.2-50 Section R403.3.3; termite damage (Repealed)**

Sec. 50. *(Repealed by Fire Prevention and Building Safety Commission; filed Jun 13, 2005, 3:00 p.m.: 28 IR 3304, eff 90 days after filing with the Secretary of State)*

**675 IAC 14-4.2-51 Section R404.1; concrete and masonry foundation walls (Repealed)**

Sec. 51. *(Repealed by Fire Prevention and Building Safety Commission; filed Jun 13, 2005, 3:00 p.m.: 28 IR 3304, eff 90 days after filing with the Secretary of State)*

**675 IAC 14-4.2-52 Section R404.1.1; masonry foundation walls (Repealed)**



Sec. 52. *(Repealed by Fire Prevention and Building Safety Commission; filed Jun 13, 2005, 3:00 p.m.: 28 IR 3304, eff 90 days after filing with the Secretary of State)*

**675 IAC 14-4.2-53 Section R404.1.2; concrete foundation walls (Repealed)**

Sec. 53. *(Repealed by Fire Prevention and Building Safety Commission; filed Jun 13, 2005, 3:00 p.m.: 28 IR 3304, eff 90 days after filing with the Secretary of State)*

**675 IAC 14-4.2-53.7 Section R404.1.5; foundation wall thickness based on walls supported (Repealed)**

Sec. 53.7. *(Repealed by Fire Prevention and Building Safety Commission; filed Jun 13, 2005, 3:00 p.m.: 28 IR 3304, eff 90 days after filing with the Secretary of State)*

**675 IAC 14-4.2-54 Section R404.1.5.1; pier and curtain wall foundations (Repealed)**

Sec. 54. *(Repealed by Fire Prevention and Building Safety Commission; filed Jun 13, 2005, 3:00 p.m.: 28 IR 3305, eff 90 days after filing with the Secretary of State)*

**675 IAC 14-4.2-55 Section R404.2.1; wood grade (Repealed)**

Sec. 55. *(Repealed by Fire Prevention and Building Safety Commission; filed Jun 13, 2005, 3:00 p.m.: 28 IR 3305, eff 90 days after filing with the Secretary of State)*

**675 IAC 14-4.2-56 Section R404.4; insulating concrete form foundation walls (Repealed)**

Sec. 56. *(Repealed by Fire Prevention and Building Safety Commission; filed Jun 13, 2005, 3:00 p.m.: 28 IR 3305, eff 90 days after filing with the Secretary of State)*

**675 IAC 14-4.2-57 Section R404.4.7.2; termite hazards (Repealed)**

Sec. 57. *(Repealed by Fire Prevention and Building Safety Commission; filed Jun 13, 2005, 3:00 p.m.: 28 IR 3305, eff 90 days after filing with the Secretary of State)*

**675 IAC 14-4.2-58 Section R 405.2.3; drainage system (Repealed)**

Sec. 58. *(Repealed by Fire Prevention and Building Safety Commission; filed Jun 13, 2005, 3:00 p.m.: 28 IR 3305, eff 90 days after filing with the Secretary of State)*

**675 IAC 14-4.2-59 Section R406.2; concrete and masonry foundation waterproofing (Repealed)**

Sec. 59. *(Repealed by Fire Prevention and Building Safety Commission; filed Jun 13, 2005, 3:00 p.m.: 28 IR 3305, eff 90 days after filing with the Secretary of State)*

**675 IAC 14-4.2-60 Section R407.3; structural requirement (Repealed)**

Sec. 60. *(Repealed by Fire Prevention and Building Safety Commission; filed Jun 13, 2005, 3:00 p.m.: 28 IR 3305, eff 90 days after filing with the Secretary of State)*

**675 IAC 14-4.2-61 Section R408.2; openings for under-floor ventilation (Repealed)**

Sec. 61. *(Repealed by Fire Prevention and Building Safety Commission; filed Jun 13, 2005, 3:00 p.m.: 28 IR 3305, eff 90 days after filing with the Secretary of State)*

*after filing with the Secretary of State)*

**675 IAC 14-4.2-62 Section R408.3; access (Repealed)**

*Sec. 62. (Repealed by Fire Prevention and Building Safety Commission; filed Jun 13, 2005, 3:00 p.m.: 28 IR 3305, eff 90 days after filing with the Secretary of State)*

**675 IAC 14-4.2-63 Section R408.6; flood resistance (Repealed)**

*Sec. 63. (Repealed by Fire Prevention and Building Safety Commission; filed Jun 13, 2005, 3:00 p.m.: 28 IR 3305, eff 90 days after filing with the Secretary of State)*

**675 IAC 14-4.2-64 Section R502.1; general (Repealed)**

*Sec. 64. (Repealed by Fire Prevention and Building Safety Commission; filed Jun 13, 2005, 3:00 p.m.: 28 IR 3305, eff 90 days after filing with the Secretary of State)*

**675 IAC 14-4.2-65 Section R502.1.4; prefabricated wood i-joists (Repealed)**

*Sec. 65. (Repealed by Fire Prevention and Building Safety Commission; filed Jun 13, 2005, 3:00 p.m.: 28 IR 3305, eff 90 days after filing with the Secretary of State)*

**675 IAC 14-4.2-66 Section R502.2.1; decks (Repealed)**

*Sec. 66. (Repealed by Fire Prevention and Building Safety Commission; filed Jun 13, 2005, 3:00 p.m.: 28 IR 3305, eff 90 days after filing with the Secretary of State)*

**675 IAC 14-4.2-67 Figure R502.2; floor construction (Repealed)**

*Sec. 67. (Repealed by Fire Prevention and Building Safety Commission; filed Jun 13, 2005, 3:00 p.m.: 28 IR 3305, eff 90 days after filing with the Secretary of State)*

**675 IAC 14-4.2-67.5 Table R502.3.2(2); floor joists spans for common lumber species (Repealed)**

*Sec. 67.5. (Repealed by Fire Prevention and Building Safety Commission; filed Jun 13, 2005, 3:00 p.m.: 28 IR 3305, eff 90 days after filing with the Secretary of State)*

**675 IAC 14-4.2-68 Section R502.3.3; floor cantilevers (Repealed)**

*Sec. 68. (Repealed by Fire Prevention and Building Safety Commission; filed Jun 13, 2005, 3:00 p.m.: 28 IR 3305, eff 90 days after filing with the Secretary of State)*

**675 IAC 14-4.2-69 Table R502.3.3; cantilever spans for floor joists (Repealed)**

*Sec. 69. (Repealed by Fire Prevention and Building Safety Commission; filed Jun 13, 2005, 3:00 p.m.: 28 IR 3305, eff 90 days after filing with the Secretary of State)*

**675 IAC 14-4.2-69.5 Section R502.8.1; sawn lumber (Repealed)**

*Sec. 69.5. (Repealed by Fire Prevention and Building Safety Commission; filed Jun 13, 2005, 3:00 p.m.: 28 IR 3305, eff 90 days after filing with the Secretary of State)*

**675 IAC 14-4.2-69.6 Figure R502.8; cutting, notching, and drilling (Repealed)**

Sec. 69.6. *(Repealed by Fire Prevention and Building Safety Commission; filed Jun 13, 2005, 3:00 p.m.: 28 IR 3305, eff 90 days after filing with the Secretary of State)*

**675 IAC 14-4.2-70 Section R502.11.1; design (Repealed)**

Sec. 70. *(Repealed by Fire Prevention and Building Safety Commission; filed Jun 13, 2005, 3:00 p.m.: 28 IR 3305, eff 90 days after filing with the Secretary of State)*

**675 IAC 14-4.2-71 Section R502.11.3; alterations to trusses (Repealed)**

Sec. 71. *(Repealed by Fire Prevention and Building Safety Commission; filed Jun 13, 2005, 3:00 p.m.: 28 IR 3305, eff 90 days after filing with the Secretary of State)*

**675 IAC 14-4.2-72 Section R502.11.4; truss design drawings (Repealed)**

Sec. 72. *(Repealed by Fire Prevention and Building Safety Commission; filed Jun 13, 2005, 3:00 p.m.: 28 IR 3305, eff 90 days after filing with the Secretary of State)*

**675 IAC 14-4.2-73 Section R602.1; identification (Repealed)**

Sec. 73. *(Repealed by Fire Prevention and Building Safety Commission; filed Jun 13, 2005, 3:00 p.m.: 28 IR 3305, eff 90 days after filing with the Secretary of State)*

**675 IAC 14-4.2-73.5 Table R602.3(1); fastener schedule for structural members (Repealed)**

Sec. 73.5. *(Repealed by Fire Prevention and Building Safety Commission; filed Jun 13, 2005, 3:00 p.m.: 28 IR 3305, eff 90 days after filing with the Secretary of State)*

**675 IAC 14-4.2-74 Figure R602.3(1); typical wall, floor, and roof framing (Repealed)**

Sec. 74. *(Repealed by Fire Prevention and Building Safety Commission; filed Jun 13, 2005, 3:00 p.m.: 28 IR 3305, eff 90 days after filing with the Secretary of State)*

**675 IAC 14-4.2-75 Figure R602.3(2); framing details (Repealed)**

Sec. 75. *(Repealed by Fire Prevention and Building Safety Commission; filed Jun 13, 2005, 3:00 p.m.: 28 IR 3305, eff 90 days after filing with the Secretary of State)*

**675 IAC 14-4.2-75.5 Table R602.3.1; stud spacing (Repealed)**

Sec. 75.5. *(Repealed by Fire Prevention and Building Safety Commission; filed Jun 13, 2005, 3:00 p.m.: 28 IR 3305, eff 90 days after filing with the Secretary of State)*

**675 IAC 14-4.2-76 Section R602.6.1; drilling and notching of top plate (Repealed)**

Sec. 76. *(Repealed by Fire Prevention and Building Safety Commission; filed Jun 13, 2005, 3:00 p.m.: 28 IR 3305, eff 90 days after filing with the Secretary of State)*

**675 IAC 14-4.2-77 Figure R602.6.1; top plate framing to accommodate piping (Repealed)**

Sec. 77. (Repealed by Fire Prevention and Building Safety Commission; filed Jun 13, 2005, 3:00 p.m.: 28 IR 3305, eff 90 days after filing with the Secretary of State)

**675 IAC 14-4.2-77.5 Figure R602.7.2; typical wood structural panel box header construction (Repealed)**

Sec. 77.5. (Repealed by Fire Prevention and Building Safety Commission; filed Jun 13, 2005, 3:00 p.m.: 28 IR 3305, eff 90 days after filing with the Secretary of State)

**675 IAC 14-4.2-77.6 Section R602.7; headers (Repealed)**

Sec. 77.6. (Repealed by Fire Prevention and Building Safety Commission; filed Jun 13, 2005, 3:00 p.m.: 28 IR 3305, eff 90 days after filing with the Secretary of State)

**675 IAC 14-4.2-77.7 Section R602.8.1; materials (Repealed)**

Sec. 77.7. (Repealed by Fire Prevention and Building Safety Commission; filed Jun 13, 2005, 3:00 p.m.: 28 IR 3305, eff 90 days after filing with the Secretary of State)

**675 IAC 14-4.2-78 Table R602.10.3; wall bracing (Repealed)**

Sec. 78. (Repealed by Fire Prevention and Building Safety Commission; filed Jun 13, 2005, 3:00 p.m.: 28 IR 3305, eff 90 days after filing with the Secretary of State)

**675 IAC 14-4.2-78.5 Table R603.6(5); header to king stud connection requirements (Repealed)**

Sec. 78.5. (Repealed by Fire Prevention and Building Safety Commission; filed Jun 13, 2005, 3:00 p.m.: 28 IR 3305, eff 90 days after filing with the Secretary of State)

**675 IAC 14-4.2-79 Section R604.1; identification and grade (Repealed)**

Sec. 79. (Repealed by Fire Prevention and Building Safety Commission; filed Jun 13, 2005, 3:00 p.m.: 28 IR 3305, eff 90 days after filing with the Secretary of State)

**675 IAC 14-4.2-80 Section R605.1; identification and grade (Repealed)**

Sec. 80. (Repealed by Fire Prevention and Building Safety Commission; filed Jun 13, 2005, 3:00 p.m.: 28 IR 3305, eff 90 days after filing with the Secretary of State)

**675 IAC 14-4.2-81 Section R606.1.1; professional registration not required (Repealed)**

Sec. 81. (Repealed by Fire Prevention and Building Safety Commission; filed Jun 13, 2005, 3:00 p.m.: 28 IR 3305, eff 90 days after filing with the Secretary of State)

**675 IAC 14-4.2-81.2 Section R606.2; thickness of masonry (Repealed)**

Sec. 81.2. (Repealed by Fire Prevention and Building Safety Commission; filed Jun 13, 2005, 3:00 p.m.: 28 IR 3305, eff 90 days after filing with the Secretary of State)

**675 IAC 14-4.2-81.3 Section R606.2.1; minimum thickness (Repealed)**

Sec. 81.3. *(Repealed by Fire Prevention and Building Safety Commission; filed Jun 13, 2005, 3:00 p.m.: 28 IR 3305, eff 90 days after filing with the Secretary of State)*

**675 IAC 14-4.2-81.7 Section R606.10; anchorage (Repealed)**

Sec. 81.7. *(Repealed by Fire Prevention and Building Safety Commission; filed Jun 13, 2005, 3:00 p.m.: 28 IR 3305, eff 90 days after filing with the Secretary of State)*

**675 IAC 14-4.2-82 Section R606.11; seismic requirements (Repealed)**

Sec. 82. *(Repealed by Fire Prevention and Building Safety Commission; filed Jun 13, 2005, 3:00 p.m.: 28 IR 3305, eff 90 days after filing with the Secretary of State)*

**675 IAC 14-4.2-83 Section R606.11.2; seismic design Category C (Repealed)**

Sec. 83. *(Repealed by Fire Prevention and Building Safety Commission; filed Jun 13, 2005, 3:00 p.m.: 28 IR 3305, eff 90 days after filing with the Secretary of State)*

**675 IAC 14-4.2-84 Figure R606.10(2); requirements for reinforced grouted masonry construction in Seismic Design Category C (Repealed)**

Sec. 84. *(Repealed by Fire Prevention and Building Safety Commission; filed Jun 13, 2005, 3:00 p.m.: 28 IR 3305, eff 90 days after filing with the Secretary of State)*

**675 IAC 14-4.2-84.5 Section R607.1.2; masonry in seismic design categories A, B, C and C<sub>1</sub> (Repealed)**

Sec. 84.5. *(Repealed by Fire Prevention and Building Safety Commission; filed Jun 13, 2005, 3:00 p.m.: 28 IR 3305, eff 90 days after filing with the Secretary of State)*

**675 IAC 14-4.2-85 Section R609.1.5; cleanouts (Repealed)**

Sec. 85. *(Repealed by Fire Prevention and Building Safety Commission; filed Jun 13, 2005, 3:00 p.m.: 28 IR 3305, eff 90 days after filing with the Secretary of State)*

**675 IAC 14-4.2-85.5 Section R609.2.2; grout spaces (Repealed)**

Sec. 85.5. *(Repealed by Fire Prevention and Building Safety Commission; filed Jun 13, 2005, 3:00 p.m.: 28 IR 3305, eff 90 days after filing with the Secretary of State)*

**675 IAC 14-4.2-86 Section R609.4.1; construction (Repealed)**

Sec. 86. *(Repealed by Fire Prevention and Building Safety Commission; filed Jun 13, 2005, 3:00 p.m.: 28 IR 3305, eff 90 days after filing with the Secretary of State)*

**675 IAC 14-4.2-87 Section R611.1; general (Repealed)**

Sec. 87. *(Repealed by Fire Prevention and Building Safety Commission; filed Jun 13, 2005, 3:00 p.m.: 28 IR 3305, eff 90 days after filing with the Secretary of State)*

**675 IAC 14-4.2-88 Section R702.4.2; gypsum backer (Repealed)**

Sec. 88. *(Repealed by Fire Prevention and Building Safety Commission; filed Jun 13, 2005, 3:00 p.m.: 28 IR 3305, eff 90 days after filing with the Secretary of State)*

**675 IAC 14-4.2-89 Section R 703.4; attachments (Repealed)**

Sec. 89. *(Repealed by Fire Prevention and Building Safety Commission; filed Jun 13, 2005, 3:00 p.m.: 28 IR 3305, eff 90 days after filing with the Secretary of State)*

**675 IAC 14-4.2-89.2 Table R703.4; weather-resistant siding attachment and minimum thickness (Repealed)**

Sec. 89.2. *(Repealed by Fire Prevention and Building Safety Commission; filed Jun 13, 2005, 3:00 p.m.: 28 IR 3305, eff 90 days after filing with the Secretary of State)*

**675 IAC 14-4.2-89.5 Section R703.7; stone and masonry veneer, general (Repealed)**

Sec. 89.5. *(Repealed by Fire Prevention and Building Safety Commission; filed Jun 13, 2005, 3:00 p.m.: 28 IR 3305, eff 90 days after filing with the Secretary of State)*

**675 IAC 14-4.2-89.6 Section R703.7.4.3; mortar or grout filled (Repealed)**

Sec. 89.6. *(Repealed by Fire Prevention and Building Safety Commission; filed Jun 13, 2005, 3:00 p.m.: 28 IR 3305, eff 90 days after filing with the Secretary of State)*

**675 IAC 14-4.2-89.7 Section R703.3.5; flashing (Repealed)**

Sec. 89.7. *(Repealed by Fire Prevention and Building Safety Commission; filed Feb 23, 2004, 8:34 a.m.: 27 IR 2278)*

**675 IAC 14-4.2-89.8 Section R703.7.6; weepholes (Repealed)**

Sec. 89.8. *(Repealed by Fire Prevention and Building Safety Commission; filed Jun 13, 2005, 3:00 p.m.: 28 IR 3305, eff 90 days after filing with the Secretary of State)*

**675 IAC 14-4.2-89.9 Sections R703.7.2.1; support by a steel angle; R703.7.2.2; support by roof construction; and R703.7.4.2; air space (Repealed)**

Sec. 89.9. *(Repealed by Fire Prevention and Building Safety Commission; filed Jun 13, 2005, 3:00 p.m.: 28 IR 3305, eff 90 days after filing with the Secretary of State)*

**675 IAC 14-4.2-89.10 Section R703.7.2.2; support by roof construction (Repealed)**

Sec. 89.10. *(Repealed by Fire Prevention and Building Safety Commission; filed Feb 23, 2004, 8:34 a.m.: 27 IR 2278)*

**675 IAC 14-4.2-89.11 Section R703.8; flashing (Repealed)**

Sec. 89.11. *(Repealed by Fire Prevention and Building Safety Commission; filed Feb 23, 2004, 8:34 a.m.: 27 IR 2278)*

**675 IAC 14-4.2-90 Section R703.8; flashing (Repealed)**

Sec. 90. *(Repealed by Fire Prevention and Building Safety Commission; filed Jun 13, 2005, 3:00 p.m.: 28 IR 3305, eff 90 days after filing with the Secretary of State)*

**675 IAC 14-4.2-91 Section R802.1; identification and grade (Repealed)**

Sec. 91. *(Repealed by Fire Prevention and Building Safety Commission; filed Jun 13, 2005, 3:00 p.m.: 28 IR 3305, eff 90 days after filing with the Secretary of State)*

**675 IAC 14-4.2-92 Section R802.10.1; truss design drawings (Repealed)**

Sec. 92. *(Repealed by Fire Prevention and Building Safety Commission; filed Jun 13, 2005, 3:00 p.m.: 28 IR 3305, eff 90 days after filing with the Secretary of State)*

**675 IAC 14-4.2-93 Section R802.10.2; design (Repealed)**

Sec. 93. *(Repealed by Fire Prevention and Building Safety Commission; filed Jun 13, 2005, 3:00 p.m.: 28 IR 3305, eff 90 days after filing with the Secretary of State)*

**675 IAC 14-4.2-94 Section R802.10.3; bracing (Repealed)**

Sec. 94. *(Repealed by Fire Prevention and Building Safety Commission; filed Jun 13, 2005, 3:00 p.m.: 28 IR 3305, eff 90 days after filing with the Secretary of State)*

**675 IAC 14-4.2-95 Section R802.10.4; alterations to trusses (Repealed)**

Sec. 95. *(Repealed by Fire Prevention and Building Safety Commission; filed Jun 13, 2005, 3:00 p.m.: 28 IR 3305, eff 90 days after filing with the Secretary of State)*

**675 IAC 14-4.2-96 Section R802.11; roof tie-down (Repealed)**

Sec. 96. *(Repealed by Fire Prevention and Building Safety Commission; filed Jun 13, 2005, 3:00 p.m.: 28 IR 3305, eff 90 days after filing with the Secretary of State)*

**675 IAC 14-4.2-96.2 TABLE R802.11 (Repealed)**

Sec. 96.2. *(Repealed by Fire Prevention and Building Safety Commission; filed Jun 13, 2005, 3:00 p.m.: 28 IR 3305, eff 90 days after filing with the Secretary of State)*

**675 IAC 14-4.2-97 Section R803.2.1; identification and grade (Repealed)**

Sec. 97. *(Repealed by Fire Prevention and Building Safety Commission; filed Jun 13, 2005, 3:00 p.m.: 28 IR 3305, eff 90 days after filing with the Secretary of State)*

**675 IAC 14-4.2-97.5 Section R806.1; ventilation required (Repealed)**

Sec. 97.5. *(Repealed by Fire Prevention and Building Safety Commission; filed Jun 13, 2005, 3:00 p.m.: 28 IR 3305, eff 90 days after filing with the Secretary of State)*

**675 IAC 14-4.2-97.9 Section R808.1; combustible insulation (Repealed)**

Sec. 97.9. *(Repealed by Fire Prevention and Building Safety Commission; filed Jun 13, 2005, 3:00 p.m.: 28 IR 3305, eff 90 days after filing with the Secretary of State)*

**675 IAC 14-4.2-98 Section R903.4.1; overflow drains and scuppers (Repealed)**

Sec. 98. *(Repealed by Fire Prevention and Building Safety Commission; filed Jun 13, 2005, 3:00 p.m.: 28 IR 3305, eff 90 days after filing with the Secretary of State)*

**675 IAC 14-4.2-99 Section R904.3; material specifications and physical characteristics (Repealed)**

Sec. 99. *(Repealed by Fire Prevention and Building Safety Commission; filed Jun 13, 2005, 3:00 p.m.: 28 IR 3305, eff 90 days after filing with the Secretary of State)*

**675 IAC 14-4.2-100 Section R907.1; general (Repealed)**

Sec. 100. *(Repealed by Fire Prevention and Building Safety Commission; filed Jun 13, 2005, 3:00 p.m.: 28 IR 3305, eff 90 days after filing with the Secretary of State)*

**675 IAC 14-4.2-101 Section R907.3; recovering versus replacement (Repealed)**

Sec. 101. *(Repealed by Fire Prevention and Building Safety Commission; filed Jun 13, 2005, 3:00 p.m.: 28 IR 3305, eff 90 days after filing with the Secretary of State)*

**675 IAC 14-4.2-102 Section R1001.6; termination (Repealed)**

Sec. 102. *(Repealed by Fire Prevention and Building Safety Commission; filed Jun 13, 2005, 3:00 p.m.: 28 IR 3305, eff 90 days after filing with the Secretary of State)*

**675 IAC 14-4.2-103 Figure R1001.6; chimney termination (Repealed)**

Sec. 103. *(Repealed by Fire Prevention and Building Safety Commission; filed Jun 13, 2005, 3:00 p.m.: 28 IR 3305, eff 90 days after filing with the Secretary of State)*

**675 IAC 14-4.2-104 Section R1001.6.1; spark arrestors (Repealed)**

Sec. 104. *(Repealed by Fire Prevention and Building Safety Commission; filed Jun 13, 2005, 3:00 p.m.: 28 IR 3305, eff 90 days after filing with the Secretary of State)*

**675 IAC 14-4.2-105 Section R1003.3; seismic reinforcing (Repealed)**

Sec. 105. *(Repealed by Fire Prevention and Building Safety Commission; filed Jun 13, 2005, 3:00 p.m.: 28 IR 3305, eff 90 days after filing with the Secretary of State)*

**675 IAC 14-4.2-105.5 Section R1003; seismic anchorage (Repealed)**

Sec. 105.5. *(Repealed by Fire Prevention and Building Safety Commission; filed Jun 13, 2005, 3:00 p.m.: 28 IR 3305, eff 90 days after filing with the Secretary of State)*

**675 IAC 14-4.2-106 Section R1005.1; exterior air (Repealed)**

Sec. 106. *(Repealed by Fire Prevention and Building Safety Commission; filed Jun 13, 2005, 3:00 p.m.: 28 IR 3305, eff 90 days after filing with the Secretary of State)*

**675 IAC 14-4.2-107 Chapter 11; energy efficiency (Repealed)**

Sec. 107. *(Repealed by Fire Prevention and Building Safety Commission; filed Jun 13, 2005, 3:00 p.m.: 28 IR 3305, eff 90 days after filing with the Secretary of State)*



days after filing with the Secretary of State)

**675 IAC 14-4.2-108 Section M1201.1; scope (Repealed)**

Sec. 108. (Repealed by Fire Prevention and Building Safety Commission; filed Jun 13, 2005, 3:00 p.m.: 28 IR 3305, eff 90 days after filing with the Secretary of State)

**675 IAC 14-4.2-109 Section M1201.2; application (Repealed)**

Sec. 109. (Repealed by Fire Prevention and Building Safety Commission; filed Jun 13, 2005, 3:00 p.m.: 28 IR 3305, eff 90 days after filing with the Secretary of State)

**675 IAC 14-4.2-110 Section M1202; existing mechanical systems (Repealed)**

Sec. 110. (Repealed by Fire Prevention and Building Safety Commission; filed Jun 13, 2005, 3:00 p.m.: 28 IR 3305, eff 90 days after filing with the Secretary of State)

**675 IAC 14-4.2-111 Section M1303.1; label information (Repealed)**

Sec. 111. (Repealed by Fire Prevention and Building Safety Commission; filed Jun 13, 2005, 3:00 p.m.: 28 IR 3305, eff 90 days after filing with the Secretary of State)

**675 IAC 14-4.2-112 Section M1307.3.1; protection from impact (Repealed)**

Sec. 112. (Repealed by Fire Prevention and Building Safety Commission; filed Jun 13, 2005, 3:00 p.m.: 28 IR 3305, eff 90 days after filing with the Secretary of State)

**675 IAC 14-4.2-112.5 Section M1411.3.1; auxiliary and secondary drain systems (Repealed)**

Sec. 112.5. (Repealed by Fire Prevention and Building Safety Commission; filed Jun 13, 2005, 3:00 p.m.: 28 IR 3305, eff 90 days after filing with the Secretary of State)

**675 IAC 14-4.2-113 Section M1501.3; length limitation (Repealed)**

Sec. 113. (Repealed by Fire Prevention and Building Safety Commission; filed Jun 13, 2005, 3:00 p.m.: 28 IR 3305, eff 90 days after filing with the Secretary of State)

**675 IAC 14-4.2-114 Section M1503.1; installation of microwave oven over a cooking appliance (Repealed)**

Sec. 114. (Repealed by Fire Prevention and Building Safety Commission; filed Jun 13, 2005, 3:00 p.m.: 28 IR 3305, eff 90 days after filing with the Secretary of State)

**675 IAC 14-4.2-115 Chapter 19; special fuel-burning equipment (Repealed)**

Sec. 115. (Repealed by Fire Prevention and Building Safety Commission; filed Jun 13, 2005, 3:00 p.m.: 28 IR 3305, eff 90 days after filing with the Secretary of State)

**675 IAC 14-4.2-116 Section M2001; boilers (Repealed)**

Sec. 116. (Repealed by Fire Prevention and Building Safety Commission; filed Jun 13, 2005, 3:00 p.m.: 28 IR 3305, eff 90 days after filing with the Secretary of State)

**675 IAC 14-4.2-117 Section M2005.5; anchorage of water heaters in seismic design Category C<sub>1</sub> (Repealed)**

Sec. 117. *(Repealed by Fire Prevention and Building Safety Commission; filed Jun 13, 2005, 3:00 p.m.: 28 IR 3305, eff 90 days after filing with the Secretary of State)*

**675 IAC 14-4.2-118 Section M2006; pool heaters (Repealed)**

Sec. 118. *(Repealed by Fire Prevention and Building Safety Commission; filed Jun 13, 2005, 3:00 p.m.: 28 IR 3305, eff 90 days after filing with the Secretary of State)*

**675 IAC 14-4.2-119 Section M2201.3; underground tanks (Repealed)**

Sec. 119. *(Repealed by Fire Prevention and Building Safety Commission; filed Jun 13, 2005, 3:00 p.m.: 28 IR 3305, eff 90 days after filing with the Secretary of State)*

**675 IAC 14-4.2-120 Section M2301.1; general (Repealed)**

Sec. 120. *(Repealed by Fire Prevention and Building Safety Commission; filed Jun 13, 2005, 3:00 p.m.: 28 IR 3305, eff 90 days after filing with the Secretary of State)*

**675 IAC 14-4.2-121 Section G2401.1; application (Repealed)**

Sec. 121. *(Repealed by Fire Prevention and Building Safety Commission; filed Jun 13, 2005, 3:00 p.m.: 28 IR 3305, eff 90 days after filing with the Secretary of State)*

**675 IAC 14-4.2-122 Section G2403; general definitions (Repealed)**

Sec. 122. *(Repealed by Fire Prevention and Building Safety Commission; filed Jun 13, 2005, 3:00 p.m.: 28 IR 3305, eff 90 days after filing with the Secretary of State)*

**675 IAC 14-4.2-123 Section G2404.7; flood hazard (Repealed)**

Sec. 123. *(Repealed by Fire Prevention and Building Safety Commission; filed Jun 13, 2005, 3:00 p.m.: 28 IR 3305, eff 90 days after filing with the Secretary of State)*

**675 IAC 14-4.2-124 Section G2405.1; structural safety (Repealed)**

Sec. 124. *(Repealed by Fire Prevention and Building Safety Commission; filed Jun 13, 2005, 3:00 p.m.: 28 IR 3305, eff 90 days after filing with the Secretary of State)*

**675 IAC 14-4.2-125 Section G2407.4 and Section G2407.5; process air and ventilation air (Repealed)**

Sec. 125. *(Repealed by Fire Prevention and Building Safety Commission; filed Jun 13, 2005, 3:00 p.m.: 28 IR 3305, eff 90 days after filing with the Secretary of State)*

**675 IAC 14-4.2-126 Section G2408.1; general (Repealed)**

Sec. 126. *(Repealed by Fire Prevention and Building Safety Commission; filed Jun 13, 2005, 3:00 p.m.: 28 IR 3305, eff 90 days after filing with the Secretary of State)*

**675 IAC 14-4.2-127 Section G2408.3; private garages (Repealed)**

Sec. 127. *(Repealed by Fire Prevention and Building Safety Commission; filed Jun 13, 2005, 3:00 p.m.: 28 IR 3305, eff 90 days after filing with the Secretary of State)*

**675 IAC 14-4.2-128 Section G2411.1; scope (Repealed)**

Sec. 128. *(Repealed by Fire Prevention and Building Safety Commission; filed Jun 13, 2005, 3:00 p.m.: 28 IR 3305, eff 90 days after filing with the Secretary of State)*

**675 IAC 14-4.2-129 Section G2411.1.1; utility piping systems located within buildings (Repealed)**

Sec. 129. *(Repealed by Fire Prevention and Building Safety Commission; filed Jun 13, 2005, 3:00 p.m.: 28 IR 3305, eff 90 days after filing with the Secretary of State)*

**675 IAC 14-4.2-130 Section G2412.2; maximum gas demand (Repealed)**

Sec. 130. *(Repealed by Fire Prevention and Building Safety Commission; filed Jun 13, 2005, 3:00 p.m.: 28 IR 3305, eff 90 days after filing with the Secretary of State)*

**675 IAC 14-4.2-131 Section G2413.1; material application (Repealed)**

Sec. 131. *(Repealed by Fire Prevention and Building Safety Commission; filed Jun 13, 2005, 3:00 p.m.: 28 IR 3305, eff 90 days after filing with the Secretary of State)*

**675 IAC 14-4.2-132 Section G2413.3; other materials (Repealed)**

Sec. 132. *(Repealed by Fire Prevention and Building Safety Commission; filed Jun 13, 2005, 3:00 p.m.: 28 IR 3305, eff 90 days after filing with the Secretary of State)*

**675 IAC 14-4.2-133 Section G2414.3; piping in concealed locations (Repealed)**

Sec. 133. *(Repealed by Fire Prevention and Building Safety Commission; filed Jun 13, 2005, 3:00 p.m.: 28 IR 3305, eff 90 days after filing with the Secretary of State)*

**675 IAC 14-4.2-134 Section G2414.8; protection against corrosion (Repealed)**

Sec. 134. *(Repealed by Fire Prevention and Building Safety Commission; filed Jun 13, 2005, 3:00 p.m.: 28 IR 3305, eff 90 days after filing with the Secretary of State)*

**675 IAC 14-4.2-135 Section G2414.9.1; individual outside appliances (Repealed)**

Sec. 135. *(Repealed by Fire Prevention and Building Safety Commission; filed Jun 13, 2005, 3:00 p.m.: 28 IR 3305, eff 90 days after filing with the Secretary of State)*

**675 IAC 14-4.2-136 Section G2414.16; testing of piping (Repealed)**

Sec. 136. *(Repealed by Fire Prevention and Building Safety Commission; filed Jun 13, 2005, 3:00 p.m.: 28 IR 3305, eff 90 days after filing with the Secretary of State)*

**675 IAC 14-4.2-137 Section G2416; inspection, testing, and purging (Repealed)**

Sec. 137. *(Repealed by Fire Prevention and Building Safety Commission; filed Jun 13, 2005, 3:00 p.m.: 28 IR 3305, eff 90 days after filing with the Secretary of State)*

*days after filing with the Secretary of State)*

**675 IAC 14-4.2-138 Section G2416.6.2; before turning gas on (Repealed)**

*Sec. 138. (Repealed by Fire Prevention and Building Safety Commission; filed Jun 13, 2005, 3:00 p.m.: 28 IR 3305, eff 90 days after filing with the Secretary of State)*

**675 IAC 14-4.2-139 Section G2416.6.3; test for leakage (Repealed)**

*Sec. 139. (Repealed by Fire Prevention and Building Safety Commission; filed Jun 13, 2005, 3:00 p.m.: 28 IR 3305, eff 90 days after filing with the Secretary of State)*

**675 IAC 14-4.2-140 Section G2416.7.1; removal from service (Repealed)**

*Sec. 140. (Repealed by Fire Prevention and Building Safety Commission; filed Jun 13, 2005, 3:00 p.m.: 28 IR 3305, eff 90 days after filing with the Secretary of State)*

**675 IAC 14-4.2-141 Section G2419.2; meter valve (Repealed)**

*Sec. 141. (Repealed by Fire Prevention and Building Safety Commission; filed Jun 13, 2005, 3:00 p.m.: 28 IR 3305, eff 90 days after filing with the Secretary of State)*

**675 IAC 14-4.2-142 Section G2422; CNG gas-dispensing systems (Repealed)**

*Sec. 142. (Repealed by Fire Prevention and Building Safety Commission; filed Jun 13, 2005, 3:00 p.m.: 28 IR 3305, eff 90 days after filing with the Secretary of State)*

**675 IAC 14-4.2-143 Section G2424.1; scope (Repealed)**

*Sec. 143. (Repealed by Fire Prevention and Building Safety Commission; filed Jun 13, 2005, 3:00 p.m.: 28 IR 3305, eff 90 days after filing with the Secretary of State)*

**675 IAC 14-4.2-144 Section G2426.8; venting system location (Repealed)**

*Sec. 144. (Repealed by Fire Prevention and Building Safety Commission; filed Jun 13, 2005, 3:00 p.m.: 28 IR 3305, eff 90 days after filing with the Secretary of State)*

**675 IAC 14-4.2-145 Section G2426.9; condensation drain (Repealed)**

*Sec. 145. (Repealed by Fire Prevention and Building Safety Commission; filed Jun 13, 2005, 3:00 p.m.: 28 IR 3305, eff 90 days after filing with the Secretary of State)*

**675 IAC 14-4.2-146 Section G2426.6.10; marking (Repealed)**

*Sec. 146. (Repealed by Fire Prevention and Building Safety Commission; filed Jun 13, 2005, 3:00 p.m.: 28 IR 3305, eff 90 days after filing with the Secretary of State)*

**675 IAC 14-4.2-147 Section G2427.1; definitions (Repealed)**

*Sec. 147. (Repealed by Fire Prevention and Building Safety Commission; filed Jun 13, 2005, 3:00 p.m.: 28 IR 3305, eff 90 days after filing with the Secretary of State)*

**675 IAC 14-4.2-148 Section G2430.1; scope (Repealed)**

Sec. 148. *(Repealed by Fire Prevention and Building Safety Commission; filed Jun 13, 2005, 3:00 p.m.: 28 IR 3305, eff 90 days after filing with the Secretary of State)*

**675 IAC 14-4.2-149 Section G2436; clothes dryer (Repealed)**

Sec. 149. *(Repealed by Fire Prevention and Building Safety Commission; filed Jun 13, 2005, 3:00 p.m.: 28 IR 3305, eff 90 days after filing with the Secretary of State)*

**675 IAC 14-4.2-150 Section G2437.5.1; maximum length (Repealed)**

Sec. 150. *(Repealed by Fire Prevention and Building Safety Commission; filed Jun 13, 2005, 3:00 p.m.: 28 IR 3305, eff 90 days after filing with the Secretary of State)*

**675 IAC 14-4.2-151 Section G2438; sauna heaters (Repealed)**

Sec. 151. *(Repealed by Fire Prevention and Building Safety Commission; filed Jun 13, 2005, 3:00 p.m.: 28 IR 3305, eff 90 days after filing with the Secretary of State)*

**675 IAC 14-4.2-152 Section G2439; pool and spa heaters (Repealed)**

Sec. 152. *(Repealed by Fire Prevention and Building Safety Commission; filed Jun 13, 2005, 3:00 p.m.: 28 IR 3305, eff 90 days after filing with the Secretary of State)*

**675 IAC 14-4.2-153 Section G2445; cooking appliances (Repealed)**

Sec. 153. *(Repealed by Fire Prevention and Building Safety Commission; filed Jun 13, 2005, 3:00 p.m.: 28 IR 3305, eff 90 days after filing with the Secretary of State)*

**675 IAC 14-4.2-154 Section G2446.1; general (Repealed)**

Sec. 154. *(Repealed by Fire Prevention and Building Safety Commission; filed Jun 13, 2005, 3:00 p.m.: 28 IR 3305, eff 90 days after filing with the Secretary of State)*

**675 IAC 14-4.2-155 Section G2450.1; general (Repealed)**

Sec. 155. *(Repealed by Fire Prevention and Building Safety Commission; filed Jun 13, 2005, 3:00 p.m.: 28 IR 3305, eff 90 days after filing with the Secretary of State)*

**675 IAC 14-4.2-156 Section P2501; general (Repealed)**

Sec. 156. *(Repealed by Fire Prevention and Building Safety Commission; filed Jun 13, 2005, 3:00 p.m.: 28 IR 3305, eff 90 days after filing with the Secretary of State)*

**675 IAC 14-4.2-157 Section P2502; existing plumbing systems (Repealed)**

Sec. 157. *(Repealed by Fire Prevention and Building Safety Commission; filed Jun 13, 2005, 3:00 p.m.: 28 IR 3305, eff 90 days after filing with the Secretary of State)*

**675 IAC 14-4.2-158 Section P2503.1; inspection required (Repealed)**

Sec. 158. *(Repealed by Fire Prevention and Building Safety Commission; filed Jun 13, 2005, 3:00 p.m.: 28 IR 3305, eff 90 days after filing with the Secretary of State)*

**675 IAC 14-4.2-159 Section P2503.2; concealment (Repealed)**

Sec. 159. *(Repealed by Fire Prevention and Building Safety Commission; filed Jun 13, 2005, 3:00 p.m.: 28 IR 3305, eff 90 days after filing with the Secretary of State)*

**675 IAC 14-4.2-160 Section P2503.3; responsibility of permitter (Repealed)**

Sec. 160. *(Repealed by Fire Prevention and Building Safety Commission; filed Jun 13, 2005, 3:00 p.m.: 28 IR 3305, eff 90 days after filing with the Secretary of State)*

**675 IAC 14-4.2-161 Section P2503.5.2; finished plumbing (Repealed)**

Sec. 161. *(Repealed by Fire Prevention and Building Safety Commission; filed Jun 13, 2005, 3:00 p.m.: 28 IR 3305, eff 90 days after filing with the Secretary of State)*

**675 IAC 14-4.2-162 Section P2503.7; inspection and testing of backflow prevention devices (Repealed)**

Sec. 162. *(Repealed by Fire Prevention and Building Safety Commission; filed Jun 13, 2005, 3:00 p.m.: 28 IR 3305, eff 90 days after filing with the Secretary of State)*

**675 IAC 14-4.2-163 Section P2503.7.1; inspections (Repealed)**

Sec. 163. *(Repealed by Fire Prevention and Building Safety Commission; filed Jun 13, 2005, 3:00 p.m.: 28 IR 3305, eff 90 days after filing with the Secretary of State)*

**675 IAC 14-4.2-164 Section P2503.7.2; testing (Repealed)**

Sec. 164. *(Repealed by Fire Prevention and Building Safety Commission; filed Jun 13, 2005, 3:00 p.m.: 28 IR 3305, eff 90 days after filing with the Secretary of State)*

**675 IAC 14-4.2-165 Section P2603.1; protection against physical damage (Repealed)**

Sec. 165. *(Repealed by Fire Prevention and Building Safety Commission; filed Jun 13, 2005, 3:00 p.m.: 28 IR 3305, eff 90 days after filing with the Secretary of State)*

**675 IAC 14-4.2-166 Section P2603.2.1; protection against physical damage (Repealed)**

Sec. 166. *(Repealed by Fire Prevention and Building Safety Commission; filed Jun 13, 2005, 3:00 p.m.: 28 IR 3305, eff 90 days after filing with the Secretary of State)*

**675 IAC 14-4.2-167 Section P2603.5; pipes through footings or foundation walls (Repealed)**

Sec. 167. *(Repealed by Fire Prevention and Building Safety Commission; filed Jun 13, 2005, 3:00 p.m.: 28 IR 3305, eff 90 days after filing with the Secretary of State)*

**675 IAC 14-4.2-168 Section P2604.5; inspection (Repealed)**

Sec. 168. *(Repealed by Fire Prevention and Building Safety Commission; filed Jun 13, 2005, 3:00 p.m.: 28 IR 3305, eff 90 days after filing with the Secretary of State)*

*days after filing with the Secretary of State)*

**675 IAC 14-4.2-169 Section P2706.2; standpipes (Repealed)**

Sec. 169. *(Repealed by Fire Prevention and Building Safety Commission; filed Jun 13, 2005, 3:00 p.m.: 28 IR 3305, eff 90 days after filing with the Secretary of State)*

**675 IAC 14-4.2-170 Section P2706.2.1; laundry tray connection (Repealed)**

Sec. 170. *(Repealed by Fire Prevention and Building Safety Commission; filed Jun 13, 2005, 3:00 p.m.: 28 IR 3305, eff 90 days after filing with the Secretary of State)*

**675 IAC 14-4.2-171 Section P2717.3; sink, dishwasher, and food grinder (Repealed)**

Sec. 171. *(Repealed by Fire Prevention and Building Safety Commission; filed Jun 13, 2005, 3:00 p.m.: 28 IR 3305, eff 90 days after filing with the Secretary of State)*

**675 IAC 14-4.2-171.5 Section P2801.5; required pan (Repealed)**

Sec. 171.5. *(Repealed by Fire Prevention and Building Safety Commission; filed Jun 13, 2005, 3:00 p.m.: 28 IR 3305, eff 90 days after filing with the Secretary of State)*

**675 IAC 14-4.2-172 Section P2802.2; scald protection (Repealed)**

Sec. 172. *(Repealed by Fire Prevention and Building Safety Commission; filed Jun 13, 2005, 3:00 p.m.: 28 IR 3305, eff 90 days after filing with the Secretary of State)*

**675 IAC 14-4.2-173 Section P2901.1; potable water required (Repealed)**

Sec. 173. *(Repealed by Fire Prevention and Building Safety Commission; filed Jun 13, 2005, 3:00 p.m.: 28 IR 3305, eff 90 days after filing with the Secretary of State)*

**675 IAC 14-4.2-174 Section P2903.8.5; support and protection (Repealed)**

Sec. 174. *(Repealed by Fire Prevention and Building Safety Commission; filed Jun 13, 2005, 3:00 p.m.: 28 IR 3305, eff 90 days after filing with the Secretary of State)*

**675 IAC 14-4.2-174.5 Section P2903.5; water hammer (Repealed)**

Sec. 174.5. *(Repealed by Fire Prevention and Building Safety Commission; filed Jun 13, 2005, 3:00 p.m.: 28 IR 3305, eff 90 days after filing with the Secretary of State)*

**675 IAC 14-4.2-175 Section P2903.9.1; service valve (Repealed)**

Sec. 175. *(Repealed by Fire Prevention and Building Safety Commission; filed Jun 13, 2005, 3:00 p.m.: 28 IR 3305, eff 90 days after filing with the Secretary of State)*

**675 IAC 14-4.2-176 Section P2907; drinking water treatment units (Repealed)**

Sec. 176. *(Repealed by Fire Prevention and Building Safety Commission; filed Jun 13, 2005, 3:00 p.m.: 28 IR 3305, eff 90 days after filing with the Secretary of State)*

**675 IAC 14-4.2-177 Section P3101.4 and SECTION P3103.2; extension outside a structure and frost closure (Repealed)**

Sec. 177. (Repealed by Fire Prevention and Building Safety Commission; filed Jun 13, 2005, 3:00 p.m.: 28 IR 3305, eff 90 days after filing with the Secretary of State)

**675 IAC 14-4.2-177.5 Section P3103.1; roof extension (Repealed)**

Sec. 177.5. (Repealed by Fire Prevention and Building Safety Commission; filed Jun 13, 2005, 3:00 p.m.: 28 IR 3305, eff 90 days after filing with the Secretary of State)

**675 IAC 14-4.2-178 Table P3105.1; maximum distance of fixture trap from vent (Repealed)**

Sec. 178. (Repealed by Fire Prevention and Building Safety Commission; filed Jun 13, 2005, 3:00 p.m.: 28 IR 3305, eff 90 days after filing with the Secretary of State)

**675 IAC 14-4.2-179 Section P3201.4; building traps (Repealed)**

Sec. 179. (Repealed by Fire Prevention and Building Safety Commission; filed Jun 13, 2005, 3:00 p.m.: 28 IR 3305, eff 90 days after filing with the Secretary of State)

**675 IAC 14-4.2-180 Table P3201.7; size of traps and trap arms for plumbing fixtures (Repealed)**

Sec. 180. (Repealed by Fire Prevention and Building Safety Commission; filed Jun 13, 2005, 3:00 p.m.: 28 IR 3305, eff 90 days after filing with the Secretary of State)

**675 IAC 14-4.2-181 Section E3301.2; scope (Repealed)**

Sec. 181. (Repealed by Fire Prevention and Building Safety Commission; filed Jun 13, 2005, 3:00 p.m.: 28 IR 3305, eff 90 days after filing with the Secretary of State)

**675 IAC 14-4.2-181.1 Section E3301.2; scope (Repealed)**

Sec. 181.1. (Repealed by Fire Prevention and Building Safety Commission; filed Jun 13, 2005, 3:00 p.m.: 28 IR 3305, eff 90 days after filing with the Secretary of State)

**675 IAC 14-4.2-182 Section E3301.3; not covered (Repealed)**

Sec. 182. (Repealed by Fire Prevention and Building Safety Commission; filed Jun 13, 2005, 3:00 p.m.: 28 IR 3305, eff 90 days after filing with the Secretary of State)

**675 IAC 14-4.2-182.1 Section E3302.2; penetrations of fire-resistance-rated assemblies (Repealed)**

Sec. 182.1. (Repealed by Fire Prevention and Building Safety Commission; filed Jun 13, 2005, 3:00 p.m.: 28 IR 3305, eff 90 days after filing with the Secretary of State)

**675 IAC 14-4.2-183 Section E3303.2; inspection required (Repealed)**

Sec. 183. (Repealed by Fire Prevention and Building Safety Commission; filed Jun 13, 2005, 3:00 p.m.: 28 IR 3305, eff 90 days after filing with the Secretary of State)

**675 IAC 14-4.2-184 Section E3304.2; interrupting rating (Repealed)**



Sec. 184. *(Repealed by Fire Prevention and Building Safety Commission; filed Jun 13, 2005, 3:00 p.m.: 28 IR 3305, eff 90 days after filing with the Secretary of State)*

**675 IAC 14-4.2-185 Section E3305.6; illumination (Repealed)**

Sec. 185. *(Repealed by Fire Prevention and Building Safety Commission; filed Jun 13, 2005, 3:00 p.m.: 28 IR 3305, eff 90 days after filing with the Secretary of State)*

**675 IAC 14-4.2-185.1 Section E3306.5; individual conductor insulation (Repealed)**

Sec. 185.1. *(Repealed by Fire Prevention and Building Safety Commission; filed Jun 13, 2005, 3:00 p.m.: 28 IR 3305, eff 90 days after filing with the Secretary of State)*

**675 IAC 14-4.2-186 Section E3306.6; conductors in parallel (Repealed)**

Sec. 186. *(Repealed by Fire Prevention and Building Safety Commission; filed Jun 13, 2005, 3:00 p.m.: 28 IR 3305, eff 90 days after filing with the Secretary of State)*

**675 IAC 14-4.2-187 Section E3401; general (Repealed)**

Sec. 187. *(Repealed by Fire Prevention and Building Safety Commission; filed Jun 13, 2005, 3:00 p.m.: 28 IR 3305, eff 90 days after filing with the Secretary of State)*

**675 IAC 14-4.2-187.1 Section E3501.6.2; service disconnect location (Repealed)**

Sec. 187.1. *(Repealed by Fire Prevention and Building Safety Commission; filed Jun 13, 2005, 3:00 p.m.: 28 IR 3305, eff 90 days after filing with the Secretary of State)*

**675 IAC 14-4.2-187.2 Table E3503.1; service conductor and grounding electrode conductor sizing (Repealed)**

Sec. 187.2. *(Repealed by Fire Prevention and Building Safety Commission; filed Jun 13, 2005, 3:00 p.m.: 28 IR 3305, eff 90 days after filing with the Secretary of State)*

**675 IAC 14-4.2-187.3 Section E3504.2.1; above roofs (Repealed)**

Sec. 187.3. *(Repealed by Fire Prevention and Building Safety Commission; filed Jun 13, 2005, 3:00 p.m.: 28 IR 3305, eff 90 days after filing with the Secretary of State)*

**675 IAC 14-4.2-187.4 Section E3505.5; protection of service cables against damage (Repealed)**

Sec. 187.4. *(Repealed by Fire Prevention and Building Safety Commission; filed Jun 13, 2005, 3:00 p.m.: 28 IR 3305, eff 90 days after filing with the Secretary of State)*

**675 IAC 14-4.2-188 Section E3506.3; available short-circuit current (Repealed)**

Sec. 188. *(Repealed by Fire Prevention and Building Safety Commission; filed Jun 13, 2005, 3:00 p.m.: 28 IR 3305, eff 90 days after filing with the Secretary of State)*

**675 IAC 14-4.2-189 Section E3509.7; metal gas piping bonding (Repealed)**

Sec. 189. *(Repealed by Fire Prevention and Building Safety Commission; filed Jun 13, 2005, 3:00 p.m.: 28 IR 3305, eff 90 days after filing with the Secretary of State)*

*days after filing with the Secretary of State)*

**675 IAC 14-4.2-189.2 Section E3509.8; bonding other metal piping (Repealed)**

*Sec. 189.2. (Repealed by Fire Prevention and Building Safety Commission; filed Jun 13, 2005, 3:00 p.m.: 28 IR 3305, eff 90 days after filing with the Secretary of State)*

**675 IAC 14-4.2-190 Section E3602.9.1; minimum branch circuit for ranges (Repealed)**

*Sec. 190. (Repealed by Fire Prevention and Building Safety Commission; filed Jun 13, 2005, 3:00 p.m.: 28 IR 3305, eff 90 days after filing with the Secretary of State)*

**675 IAC 14-4.2-190.1 Section E3602.10; branch circuits serving heating loads (Repealed)**

*Sec. 190.1. (Repealed by Fire Prevention and Building Safety Commission; filed Jun 13, 2005, 3:00 p.m.: 28 IR 3305, eff 90 days after filing with the Secretary of State)*

**675 IAC 14-4.2-190.2 Section E3602.12; branch circuits serving room air conditioners (Repealed)**

*Sec. 190.2. (Repealed by Fire Prevention and Building Safety Commission; filed Jun 13, 2005, 3:00 p.m.: 28 IR 3305, eff 90 days after filing with the Secretary of State)*

**675 IAC 14-4.2-190.3 Section E3602.12.1; where no other loads are supplied (Repealed)**

*Sec. 190.3. (Repealed by Fire Prevention and Building Safety Commission; filed Jun 13, 2005, 3:00 p.m.: 28 IR 3305, eff 90 days after filing with the Secretary of State)*

**675 IAC 14-4.2-190.4 Section E3602.12.2; where lighting units or other appliances are also supplied (Repealed)**

*Sec. 190.4. (Repealed by Fire Prevention and Building Safety Commission; filed Jun 13, 2005, 3:00 p.m.: 28 IR 3305, eff 90 days after filing with the Secretary of State)*

**675 IAC 14-4.2-190.5 Section E3703.3; protection from damage (Repealed)**

*Sec. 190.5. (Repealed by Fire Prevention and Building Safety Commission; filed Jun 13, 2005, 3:00 p.m.: 28 IR 3305, eff 90 days after filing with the Secretary of State)*

**675 IAC 14-4.2-191 Figure E3801.4; countertop receptacles (Repealed)**

*Sec. 191. (Repealed by Fire Prevention and Building Safety Commission; filed Jun 13, 2005, 3:00 p.m.: 28 IR 3305, eff 90 days after filing with the Secretary of State)*

**675 IAC 14-4.2-191.1 Section E3801.4.5; receptacle outlet location (Repealed)**

*Sec. 191.1. (Repealed by Fire Prevention and Building Safety Commission; filed Jun 13, 2005, 3:00 p.m.: 28 IR 3305, eff 90 days after filing with the Secretary of State)*

**675 IAC 14-4.2-191.2 Section E3801.6; bathroom (Repealed)**

*Sec. 191.2. (Repealed by Fire Prevention and Building Safety Commission; filed Jun 13, 2005, 3:00 p.m.: 28 IR 3305, eff 90 days after filing with the Secretary of State)*

**675 IAC 14-4.2-191.3 Section E3801.9; basements and garages (Repealed)**

Sec. 191.3. *(Repealed by Fire Prevention and Building Safety Commission; filed Jun 13, 2005, 3:00 p.m.: 28 IR 3305, eff 90 days after filing with the Secretary of State)*

**675 IAC 14-4.2-191.4 Section E3801.11; HVAC outlet; Section E3802; ground-fault and arc-fault circuit-interrupter protection (Repealed)**

Sec. 191.4. *(Repealed by Fire Prevention and Building Safety Commission; filed Jun 13, 2005, 3:00 p.m.: 28 IR 3305, eff 90 days after filing with the Secretary of State)*

**675 IAC 14-4.2-191.5 Section E3802.8; exempt receptacles (Repealed)**

Sec. 191.5. *(Repealed by Fire Prevention and Building Safety Commission; filed Jun 13, 2005, 3:00 p.m.: 28 IR 3305, eff 90 days after filing with the Secretary of State)*

**675 IAC 14-4.2-192 Section E3802; ground-fault and arc-fault circuit-interrupter protection (Repealed)**

Sec. 192. *(Repealed by Fire Prevention and Building Safety Commission; filed Jun 13, 2005, 3:00 p.m.: 28 IR 3305, eff 90 days after filing with the Secretary of State)*

**675 IAC 14-4.2-192.1 Section E3803.3; additional locations (Repealed)**

Sec. 192.1. *(Repealed by Fire Prevention and Building Safety Commission; filed Jun 13, 2005, 3:00 p.m.: 28 IR 3305, eff 90 days after filing with the Secretary of State)*

**675 IAC 14-4.2-192.2 Section E3805.1; box, conduit body, or fitting; where required (Repealed)**

Sec. 192.2. *(Repealed by Fire Prevention and Building Safety Commission; filed Jun 13, 2005, 3:00 p.m.: 28 IR 3305, eff 90 days after filing with the Secretary of State)*

**675 IAC 14-4.2-192.3 Section E3805.3.1; nonmetallic-sheathed cable and nonmetallic boxes (Repealed)**

Sec. 192.3. *(Repealed by Fire Prevention and Building Safety Commission; filed Jun 13, 2005, 3:00 p.m.: 28 IR 3305, eff 90 days after filing with the Secretary of State)*

**675 IAC 14-4.2-192.4 Section E3805.3.2; securing to box (Repealed)**

Sec. 192.4. *(Repealed by Fire Prevention and Building Safety Commission; filed Jun 13, 2005, 3:00 p.m.: 28 IR 3305, eff 90 days after filing with the Secretary of State)*

**675 IAC 14-4.2-192.5 Section E3806.5; in wall or ceiling (Repealed)**

Sec. 192.5. *(Repealed by Fire Prevention and Building Safety Commission; filed Jun 13, 2005, 3:00 p.m.: 28 IR 3305, eff 90 days after filing with the Secretary of State)*

**675 IAC 14-4.2-192.6 Section E3806.8.2.1; nails (Repealed)**

Sec. 192.6. *(Repealed by Fire Prevention and Building Safety Commission; filed Jun 13, 2005, 3:00 p.m.: 28 IR 3305, eff 90 days after filing with the Secretary of State)*

**675 IAC 14-4.2-193 Section E3808.7; load-side equipment (Repealed)**

Sec. 193. (Repealed by Fire Prevention and Building Safety Commission; filed Jun 13, 2005, 3:00 p.m.: 28 IR 3305, eff 90 days after filing with the Secretary of State)

**675 IAC 14-4.2-193.1 Section E3808.8; types of equipment grounding conductors (Repealed)**

Sec. 193.1. (Repealed by Fire Prevention and Building Safety Commission; filed Jun 13, 2005, 3:00 p.m.: 28 IR 3305, eff 90 days after filing with the Secretary of State)

**675 IAC 14-4.2-193.2 Section E3901.3; indicating (Repealed)**

Sec. 193.2. (Repealed by Fire Prevention and Building Safety Commission; filed Jun 13, 2005, 3:00 p.m.: 28 IR 3305, eff 90 days after filing with the Secretary of State)

**675 IAC 14-4.2-193.3 Section E3902.12; outdoor installation (Repealed)**

Sec. 193.3. (Repealed by Fire Prevention and Building Safety Commission; filed Jun 13, 2005, 3:00 p.m.: 28 IR 3305, eff 90 days after filing with the Secretary of State)

**675 IAC 14-4.2-193.4 Section E3903.11; fixtures in clothes closets (Repealed)**

Sec. 193.4. (Repealed by Fire Prevention and Building Safety Commission; filed Jun 13, 2005, 3:00 p.m.: 28 IR 3305, eff 90 days after filing with the Secretary of State)

**675 IAC 14-4.2-193.5 Table E4103.5; overhead conductor clearances (Repealed)**

Sec. 193.5. (Repealed by Fire Prevention and Building Safety Commission; filed Jun 13, 2005, 3:00 p.m.: 28 IR 3305, eff 90 days after filing with the Secretary of State)

**675 IAC 14-4.2-194 Section E4103.6; underground wiring (Repealed)**

Sec. 194. (Repealed by Fire Prevention and Building Safety Commission; filed Jun 13, 2005, 3:00 p.m.: 28 IR 3305, eff 90 days after filing with the Secretary of State)

**675 IAC 14-4.2-194.1 Section E4104.1; bonded parts (Repealed)**

Sec. 194.1. (Repealed by Fire Prevention and Building Safety Commission; filed Jun 13, 2005, 3:00 p.m.: 28 IR 3305, eff 90 days after filing with the Secretary of State)

**675 IAC 14-4.2-194.2 Section E4106.8.2; other enclosures (Repealed)**

Sec. 194.2. (Repealed by Fire Prevention and Building Safety Commission; filed Jun 13, 2005, 3:00 p.m.: 28 IR 3305, eff 90 days after filing with the Secretary of State)

**675 IAC 14-4.2-194.3 Section E4106.9.2; wiring methods (Repealed)**

Sec. 194.3. (Repealed by Fire Prevention and Building Safety Commission; filed Jun 13, 2005, 3:00 p.m.: 28 IR 3305, eff 90 days after filing with the Secretary of State)

**675 IAC 14-4.2-194.4 Section E4106.10; electrically operated pool covers (Repealed)**

Sec. 194.4. *(Repealed by Fire Prevention and Building Safety Commission; filed Jun 13, 2005, 3:00 p.m.: 28 IR 3305, eff 90 days after filing with the Secretary of State)*

**675 IAC 14-4.2-194.5 Section E4106.12.2; permanently wired radiant heaters (Repealed)**

Sec. 194.5. *(Repealed by Fire Prevention and Building Safety Commission; filed Jun 13, 2005, 3:00 p.m.: 28 IR 3305, eff 90 days after filing with the Secretary of State)*

**675 IAC 14-4.2-194.6 Section E4201.2; definitions (Repealed)**

Sec. 194.6. *(Repealed by Fire Prevention and Building Safety Commission; filed Jun 13, 2005, 3:00 p.m.: 28 IR 3305, eff 90 days after filing with the Secretary of State)*

**675 IAC 14-4.2-194.7 Section E4201.3; spread of fire or products of combustion (Repealed)**

Sec. 194.7. *(Repealed by Fire Prevention and Building Safety Commission; filed Jun 13, 2005, 3:00 p.m.: 28 IR 3305, eff 90 days after filing with the Secretary of State)*

**675 IAC 14-4.2-195 Chapter 43; referenced standards (Repealed)**

Sec. 195. *(Repealed by Fire Prevention and Building Safety Commission; filed Jun 13, 2005, 3:00 p.m.: 28 IR 3305, eff 90 days after filing with the Secretary of State)*

**675 IAC 14-4.2-196 Appendix A; sizing and capacities of gas pipe (Repealed)**

Sec. 196. *(Repealed by Fire Prevention and Building Safety Commission; filed Jun 13, 2005, 3:00 p.m.: 28 IR 3305, eff 90 days after filing with the Secretary of State)*

**675 IAC 14-4.2-197 Appendix B; sizing of venting systems serving appliances equipped with draft hoods, Category 1 appliances, and appliances listed for use and Type B vents (Repealed)**

Sec. 197. *(Repealed by Fire Prevention and Building Safety Commission; filed Jun 13, 2005, 3:00 p.m.: 28 IR 3305, eff 90 days after filing with the Secretary of State)*

**675 IAC 14-4.2-198 Appendix C; exit terminals of mechanical draft and direct-vent systems (Repealed)**

Sec. 198. *(Repealed by Fire Prevention and Building Safety Commission; filed Jun 13, 2005, 3:00 p.m.: 28 IR 3305, eff 90 days after filing with the Secretary of State)*

**675 IAC 14-4.2-199 Appendix D; recommend procedure for safety inspection of an existing appliance installation (Repealed)**

Sec. 199. *(Repealed by Fire Prevention and Building Safety Commission; filed Jun 13, 2005, 3:00 p.m.: 28 IR 3305, eff 90 days after filing with the Secretary of State)*

**675 IAC 14-4.2-200 Appendix E; manufactured housing used as dwellings (Repealed)**

Sec. 200. *(Repealed by Fire Prevention and Building Safety Commission; filed Jun 13, 2005, 3:00 p.m.: 28 IR 3305, eff 90 days after filing with the Secretary of State)*

**675 IAC 14-4.2-201 Appendix F; radon control methods (Repealed)**

Sec. 201. *(Repealed by Fire Prevention and Building Safety Commission; filed Jun 13, 2005, 3:00 p.m.: 28 IR 3305, eff 90 days after filing with the Secretary of State)*

**675 IAC 14-4.2-202 Appendix G; swimming pools, spas, and hot tubs (Repealed)**

Sec. 202. *(Repealed by Fire Prevention and Building Safety Commission; filed Jun 13, 2005, 3:00 p.m.: 28 IR 3305, eff 90 days after filing with the Secretary of State)*

**675 IAC 14-4.2-203 Appendix H; patio covers (Repealed)**

Sec. 203. *(Repealed by Fire Prevention and Building Safety Commission; filed Jun 13, 2005, 3:00 p.m.: 28 IR 3305, eff 90 days after filing with the Secretary of State)*

**675 IAC 14-4.2-204 Appendix I; private sewage disposal (Repealed)**

Sec. 204. *(Repealed by Fire Prevention and Building Safety Commission; filed Jun 13, 2005, 3:00 p.m.: 28 IR 3305, eff 90 days after filing with the Secretary of State)*

**675 IAC 14-4.2-205 Appendix J; existing buildings and structures (Repealed)**

Sec. 205. *(Repealed by Fire Prevention and Building Safety Commission; filed Jun 13, 2005, 3:00 p.m.: 28 IR 3305, eff 90 days after filing with the Secretary of State)*

**675 IAC 14-4.2-206 Appendix K; sound transmission (Repealed)**

Sec. 206. *(Repealed by Fire Prevention and Building Safety Commission; filed Jun 13, 2005, 3:00 p.m.: 28 IR 3305, eff 90 days after filing with the Secretary of State)*

**Rule 4.3. Indiana Residential Code**

**675 IAC 14-4.3-1 Adoption by reference; title; availability; purpose**

Authority: IC 22-13-2-2; IC 22-13-2-13

Affected: IC 22-12; IC 22-13; IC 22-14; IC 22-15; IC 36-7

Sec. 1. (a) That certain document being titled the 2003 International Residential Code for One and Two Family Dwellings, fifth printing, published by the International Code Council, 5203 Leesburg Pike, Suite 708, Falls Church, Virginia 22041-3401, is hereby adopted by reference as if fully set out in this rule save and except those revisions made in this rule.

(b) This rule shall be known as the Indiana Residential Code, 2005 edition, and shall be published, except incorporated documents, by the fire and building services department for general distribution and use under that title. Wherever the term "this code" is used throughout this rule, it shall mean the Indiana Residential Code, 2005 edition.

(c) This rule is available for reference and review at the Department of Fire and Building Services, Indiana Government Center-South, 402 West Washington Street, Room W246, Indianapolis, Indiana 46204.

(d) The purpose of this code is to provide minimum requirements for safety and to safeguard property, public safety, and general welfare through affordability, by regulating and controlling the design, construction, installation, and quality of materials of residential structures as regulated by this code. *(Fire Prevention and Building Safety Commission; 675 IAC 14-4.3-1; filed Jun 13, 2005, 3:00 p.m.: 28 IR 3256, eff 90 days after filing with the Secretary of State)*

**675 IAC 14-4.3-2 Chapter 1; administration**

Authority: IC 22-13-2-2; IC 22-13-2-13

Affected: IC 4-21.5; IC 4-22-7-7; IC 22-12-1-16; IC 22-12-1-17; IC 22-12-7; IC 22-13-2-7; IC 22-13-5; IC 22-14; IC 22-15; IC 25-4; IC 25-31; IC 36-7

Sec. 2. Delete Chapter 1 and substitute as follows: (a) SECTION R101 Application is added to read as follows: SECTION R101 APPLICATION

The provisions of this code apply to the construction, prefabrication, alteration, addition, and remodel of detached one or two family dwellings and one family townhouses not more than 3 stories in height and their accessory structures.

This code does not apply to manufactured homes as defined in SECTION R202, SECTION AE201, and IC 22-12-1-16 except as addressed in APPENDIX E.

This code does not apply to mobile structures as defined in IC 22-12-1-17.

Townhouses are classified as Class 1 structures and detached one and two family dwellings and their accessory structures are classified as Class 2 structures.

Provisions in the appendices are not enforceable unless specifically adopted.

The codes and standards referenced in this code shall be considered part of the requirements of this code to the prescribed extent of each such reference. Where differences occur between provisions of this code and referenced codes and standards, the provisions of this code shall apply.

EXCEPTION: Where the enforcement of a code provision would violate the listing of the equipment, appliance, manufacturer's instructions or certification of engineered products by a registered architect registered under IC 25-4 or a professional engineer registered under IC 25-31, the conditions of the listing, manufacturer's instructions, or professional certification by a registered architect or professional engineer shall apply.

(b) SECTION R102 is added to read as follows: SECTION R102 APPEALS AND INTERPRETATIONS

Appeals from orders issued by the Fire Prevention and Building Safety Commission, the state building commissioner, or the state fire marshal are governed by IC 4-21.5 and IC 22-12-7. Appeals from orders by a local unit of government are governed by IC 22-13-2-7 and local ordinance. Upon the written request of an interested person, the office of the state building commissioner may issue a written interpretation of a building law. The written interpretation as issued under IC 22-13-5 binds the interested person and the county or municipality with whom the interested person has the dispute until overruled under IC 4-21.5. A written interpretation of a building law binds all counties and municipalities if the office of the state building commissioner publishes the written interpretation of the building law in the Indiana Register under IC 4-22-7-7(b).

(c) SECTION R103 is added to read as follows: SECTION R103 PLANS

Plans shall be submitted for Class 1 structures as required by the General Administrative Rules (675 IAC 12-6) and for Class 2 structures as required by local ordinance.

(d) SECTION R104 is added to read as follows: SECTION R104 EXISTING CONSTRUCTION

For existing construction, see the General Administrative Rules (675 IAC 12-4) and local ordinance.

(e) SECTION R105 is added to read as follows: SECTION R105 ADDITIONS AND ALTERATIONS

Additions and alterations to any structure shall conform to that required for a new structure without requiring the existing structure to comply with all the requirements of this code. Additions or alterations shall not cause an existing structure to become unsafe.

(f) SECTION R106 is added to read as follows: SECTION R106 ALTERNATIVE MATERIALS, METHODS, AND EQUIPMENT

SECTION R106.1 ALTERNATE MATERIALS, METHODS, AND EQUIPMENT

The provisions of this code are not intended to limit the appropriate use of materials, appliances, equipment, or methods of design or construction not specifically prescribed by this code. The building official shall determine equivalence of the proposed alternate materials, appliances, equipment, or method of design or construction of that prescribed in this code in suitability, quality, strength, effectiveness, fire resistance, durability, dimensional stability, safety, and sanitation on the basis of evidence and/or tests as described in R106.2 and R106.3, as suitable to be approved. For Class 1 structures, alternate materials, methods, equipment, and design shall be as required by the General Administrative Rules (675 IAC 12-6-11). Compliance with specific provisions of the Indiana Building Code (675 IAC 13) or the Indiana Plumbing Code (675 IAC 16) in lieu of the requirements of this code shall be permitted as an alternate.

SECTION R106.2 EVIDENCE

The building official may require that evidence or proof be submitted to substantiate any claims that may be made regarding the

proposed alternate.

**SECTION R106.3 TESTS AND STANDARDS**

The determination of equivalence shall be based on design or test methods or approved standards. In addition, the building official may accept as supporting data to assist in this determination duly authenticated reports from the Building Officials and Code Administrators International, Inc., Southern Building Code Congress International, Inc., International Conference of Building Officials, the International Code Council, Inc., or their successors, or acceptance documents from the U.S. Department of Housing and Urban Development, the certification of a registered architect registered under IC 25-4 or a professional engineer registered under IC 25-31, or the General Administrative Rules (675 IAC 12).

Whenever there is insufficient evidence of compliance with the provisions of this code, or evidence that a material or method does not conform to the requirements of this code, or in order to substantiate claims for alternative materials or methods, the building official shall have the authority to require tests as evidence of compliance to be made at no expense to the jurisdiction. Test methods shall be as specified in this code or by other recognized test standards. Tests shall be performed by an approved agency. Reports of such test shall be retained by the building official for a period required for retention of public records.

(g) SECTION R107 is added to read as follows: SECTION R107 WORKMANSHIP

General Workmanship. All construction methods shall be accepted practices to ensure livable and safe housing and shall demonstrate acceptable workmanship. (*Fire Prevention and Building Safety Commission; 675 IAC 14-4.3-2; filed Jun 13, 2005, 3:00 p.m.: 28 IR 3256, eff 90 days after filing with the Secretary of State*)

**675 IAC 14-4.3-3 Section R202; definitions**

Authority: IC 22-13-2-2; IC 22-13-2-13

Affected: IC 22-12; IC 22-13; IC 22-14; IC 22-15; IC 36-7

Sec. 3. Change SECTION R202 Definitions as follows: (a) Change the definition of ACCESSORY STRUCTURE to read as follows: In one and two family dwellings and for the purpose of APPENDIX E, structures not more than 3 stories high with separate means of egress, and the use of which is incidental to that of the main building and which is located on the same lot.

(b) Change the definition of ALTERATION by deleting “other than repair”.

(c) Change APPROVED to read as follows: APPROVED means, as to materials, equipment, appliances, methods of design, and types of construction, acceptance by the building official by one (1) of the following methods:

- (1) investigation or tests conducted by recognized authorities;
- (2) investigation or tests conducted by technical or scientific organizations; or
- (3) accepted principles.

The investigation, tests, or principles shall establish that the materials, equipment, appliances, methods of design, and types of construction are safe for their intended purpose.

(d) Change the definition of BUILDING, EXISTING to read as follows: BUILDING, EXISTING. Existing building is a building or structure erected prior to the adoption of this code.

(e) Change the definition of BUILDING OFFICIAL to read as follows: BUILDING OFFICIAL, as used in this code, shall be the local official or officials as designated in local ordinance, except it shall be the state building commissioner for Industrialized Building Systems under 675 IAC 15 and IC 22-15 and for plan review for townhouses under 675 IAC 12 and IC 22-15.

(f) Delete the definition of CONSTRUCTION DOCUMENTS and substitute to read as follows: CONSTRUCTION DOCUMENTS. For construction documents, see the General Administrative Rules (675 IAC 12) for Class 1 structures and local ordinance for Class 2 structures.

(g) Delete from the definition of ESSENTIALLY NONTOXIC TRANSFER FLUIDS the following: “; and FDA-approved boiler water additions for steam boilers”.

(h) Change the definition of EXISTING INSTALLATIONS to read as follows: Any system regulated by this code that was legally installed prior to the effective date of this code.

(i) Add the definition of FAMILY after the definition of FACTORY-BUILT CHIMNEY to read as follows: FAMILY means an individual or 2 or more persons related by blood or marriage and/or a group of not more than 10 persons (excluding servants) who need not be related by blood or marriage living together in a dwelling unit.

(j) Add, in the definition of FOAM PLASTIC INSULATION, “of” between the words “consisting” and “open”.

(k) Add the definition of FOUNDATION WALL after FOAM PLASTIC INSULATION to read as follows: FOUNDATION WALL means the supporting element(s) that extend from the top of the footing to the bottom of the sill plate.



(l) Delete, in the definition of HEATING DEGREE DAY (HDD), “acceptable to the code” and substitute “approved by the building”.

(m) Add the following definitions after INSULATING SHEATHING:

INTERNATIONAL BUILDING CODE means the Indiana Building Code (675 IAC 13).

ICC ELECTRICAL CODE means the Indiana Electrical Code (675 IAC 17).

INTERNATIONAL FIRE CODE means the Indiana Fire Code (675 IAC 22).

INTERNATIONAL FUEL GAS CODE means the Indiana Fuel Gas Code (675 IAC 25).

INTERNATIONAL MECHANICAL CODE means the Indiana Mechanical Code (675 IAC 18).

INTERNATIONAL PLUMBING CODE means the Indiana Plumbing Code (675 IAC 16).

(n) Delete the definition of LABELED and substitute to read as follows: LABELED. Equipment or materials to which has been attached a label, symbol, or other identifying mark of an organization engaged in product evaluation that maintains periodic inspection or production of labeled equipment or materials and by whose labeling the manufacturer indicates compliance with appropriate standards or performance in a specified manner.

(o) Delete the definition of LISTED AND LISTING and substitute to read as follows: LISTED AND LISTING. Equipment or materials included in a list published by an organization engaged in product evaluation that maintains periodic inspection of production of listed equipment or materials and whose listing states either that the equipment or material meets appropriate standards or has been tested and found suitable for use in a specified manner.

(p) Add the definition of NATIONAL ELECTRICAL CODE after MULTIPLE STATION SMOKE ALARM to read as follows: NATIONAL ELECTRICAL CODE means the Indiana Electrical Code (675 IAC 17).

(q) Add the definition of NFPA 70 after NATURAL DRAFT SYSTEM to read as follows: NFPA 70 means the Indiana Electrical Code (675 IAC 17).

(r) Delete the definition of PERMIT.

(s) Delete, in the definition of PLUMBING, “, repairs, maintenance”.

(t) Delete, in the definition of PLUMBING APPURTENANCE, “, maintenance, servicing, economy”.

(u) Delete the definition of POTABLE WATER and substitute to read as follows: POTABLE WATER. Water that at the point of use is acceptable for human consumption under drinking water standards adopted by the Water Pollution Control Board at 327 IAC 8.

(v) Delete the definition of REGISTERED DESIGN PROFESSIONAL.

(w) Add the definition of RECESSED LIGHT after RECEPTOR to read as follows: RECESSED LIGHT means a light fixture that by design penetrates the thermal boundary of the building.

(x) Delete the definition of ROOF REPAIR.

(y) Add the definition of SLAB-ON-GRADE FLOOR INSULATION after SKYLIGHT AND SLOPED GLAZING to read as follows: SLAB-ON-GRADE FLOOR INSULATION means insulation around the perimeter of the floor slab or its supporting foundation.

(z) Add the definition of SMOKE ALARM after SLOPE to read as follows: SMOKE ALARM an alarm device that is responsive to smoke.

(aa) Add the definition of TACTILE NOTIFICATION APPLIANCE after SWEEP to read as follows: TACTILE NOTIFICATION APPLIANCE a notification appliance that alerts by sense of touch or vibration.

(bb) Add to the definition of TOWNHOUSE, between “units” and “in”, “separated by property lines”. (*Fire Prevention and Building Safety Commission; 675 IAC 14-4.3-3; filed Jun 13, 2005, 3:00 p.m.: 28 IR 3257, eff 90 days after filing with the Secretary of State*)

**675 IAC 14-4.3-4 Section R301.2; climatic and geographic design criteria**

Authority: IC 22-13-2-2; IC 22-13-2-13

Affected: IC 22-12; IC 22-13; IC 22-14; IC 22-15; IC 36-7

Sec. 4. Delete the last sentence of SECTION R301.2. (*Fire Prevention and Building Safety Commission; 675 IAC 14-4.3-4; filed Jun 13, 2005, 3:00 p.m.: 28 IR 3259, eff 90 days after filing with the Secretary of State*)

ONE AND TWO FAMILY DWELLING CODE

**675 IAC 14-4.3-5 Sections R301.2.1.1 and R301.2.1.2; design criteria, internal pressure**

Authority: IC 22-13-2-2; IC 22-13-2-13

Affected: IC 22-12; IC 22-13; IC 22-14; IC 22-15; IC 36-7

Sec. 5. Delete SECTIONS R301.2.1.1 and R301.2.1.2. (*Fire Prevention and Building Safety Commission; 675 IAC 14-4.3-5; filed Jun 13, 2005, 3:00 p.m.: 28 IR 3259, eff 90 days after filing with the Secretary of State*)

**675 IAC 14-4.3-6 Table R301.2(1); climatic and geographical design criteria**

Authority: IC 22-13-2-2; IC 22-13-2-13

Affected: IC 22-12; IC 22-13; IC 22-14; IC 22-15; IC 36-7

Sec. 6. Delete TABLE R301.2(1) and the corresponding footnotes and substitute to read as follows:

TABLE R301.2(1)

No.	County	Wind Speed <sup>1</sup> (MPH)	Seismic Zone <sup>2</sup>	Ground Snow (PSF)	Foundation <sup>3</sup>	Winter Design Temp	Decay	Termite	Weathering <sup>4</sup>	Ice Shield Under-layment Required	Air Freezing Index	Mean Annual Temp
01	Adams	90	B	20	36	1°	Slight to Moderate	Moderate to Heavy	Severe	Yes	1303	50.9
02	Allen	90	B	20	36	1°	Slight to Moderate	Moderate to Heavy	Severe	Yes	1490	49.9
03	Bartholomew	90	B	20	24	9°	Slight to Moderate	Moderate to Heavy	Severe	No	1083	53.1
04	Benton	90	B	20	36	1°	Slight to Moderate	Moderate to Heavy	Severe	Yes	1350	49.1
05	Blackford	90	B	20	30	2°	Slight to Moderate	Moderate to Heavy	Severe	No	1425	51.4
06	Boone	90	B	20	30	2°	Slight to Moderate	Moderate to Heavy	Severe	No	1401	52.3
07	Brown	90	B	20	24	9°	Slight to Moderate	Moderate to Heavy	Severe	No	1080	53.1
08	Carroll	90	B	20	36	1°	Slight to Moderate	Moderate to Heavy	Severe	Yes	1321	51.7
09	Cass	90	A	20	36	1°	Slight to Moderate	Moderate to Heavy	Severe	Yes	1450	50.3
10	Clark	90	B	20	24	9°	Slight to Moderate	Moderate to Heavy	Severe	No	825	54.7
11	Clay	90	C	20	24	9°	Slight to Moderate	Moderate to Heavy	Severe	No	1175	52.1
12	Clinton	90	B	20	30	2°	Slight to Moderate	Moderate to Heavy	Severe	No	1405	50.7
13	Crawford	90	C	20	24	9°	Slight to Moderate	Moderate to Heavy	Severe	No	750	54.7
14	Daviess	90	C <sub>1</sub>	20	24	9°	Slight to Moderate	Moderate to Heavy	Severe	No	743	56.1
15	Dearborn	90	B	20	24	9°	Slight to Moderate	Moderate to Heavy	Severe	No	900	50.5
16	Decatur	90	B	20	24	9°	Slight to Moderate	Moderate to Heavy	Severe	No	1115	52.4

ONE AND TWO FAMILY DWELLING CODE

17	Dekalb	90	B	30	36	1°	Slight to Moderate	Moderate to Heavy	Severe	Yes	1389	50.0
18	Delaware	90	B	20	30	2°	Slight to Moderate	Moderate to Heavy	Severe	No	1400	50.8
19	Dubois	90	C	20	24	9°	Slight to Moderate	Moderate to Heavy	Severe	No	770	53.9
20	Elkhart	90	A	30	36	1°	Slight to Moderate	Moderate to Heavy	Severe	Yes	1358	50.5
21	Fayette	90	B	20	30	2°	Slight to Moderate	Moderate to Heavy	Severe	No	1369	51.5
22	Floyd	90	B	20	24	9°	Slight to Moderate	Moderate to Heavy	Severe	No	770	54.7
23	Fountain	90	B	20	30	2°	Slight to Moderate	Moderate to Heavy	Severe	No	1525	51.2
24	Franklin	90	B	20	24	9°	Slight to Moderate	Moderate to Heavy	Severe	No	1174	51.8
25	Fulton	90	A	30	36	1°	Slight to Moderate	Moderate to Heavy	Severe	Yes	1553	49.3
26	Gibson	90	C <sub>1</sub>	20	24	9°	Slight to Moderate	Moderate to Heavy	Severe	No	893	55.2
27	Grant	90	B	20	30	2°	Slight to Moderate	Moderate to Heavy	Severe	No	1430	50.3
28	Greene	90	C	20	24	9°	Slight to Moderate	Moderate to Heavy	Severe	No	990	52.9
29	Hamilton	90	B	20	30	2°	Slight to Moderate	Moderate to Heavy	Severe	No	1400	51.5
30	Hancock	90	B	20	30	2°	Slight to Moderate	Moderate to Heavy	Severe	No	1356	51.6
31	Harrison	90	B	20	24	9°	Slight to Moderate	Moderate to Heavy	Severe	No	740	54.7
32	Hendricks	90	B	20	30	2°	Slight to Moderate	Moderate to Heavy	Severe	No	1175	52.3
33	Henry	90	B	20	30	2°	Slight to Moderate	Moderate to Heavy	Severe	No	1432	49.9
34	Howard	90	A	20	30	2°	Slight to Moderate	Moderate to Heavy	Severe	No	1523	49.6
35	Huntington	90	B	20	36	1°	Slight to Moderate	Moderate to Heavy	Severe	Yes	1270	50.4
36	Jackson	90	B	20	24	9°	Slight to Moderate	Moderate to Heavy	Severe	No	1048	52.5
37	Jasper	90	B	30	36	1°	Slight to Moderate	Moderate to Heavy	Severe	Yes	1647	49.6
38	Jay	90	B	20	30	2°	Slight to Moderate	Moderate to Heavy	Severe	No	1400	49.7
39	Jefferson	90	B	20	24	9°	Slight to Moderate	Moderate to Heavy	Severe	No	870	54.7
40	Jennings	90	B	20	24	9°	Slight to Moderate	Moderate to Heavy	Severe	No	789	54.3

ONE AND TWO FAMILY DWELLING CODE

41	Johnson	90	B	20	30	2°	Slight to Moderate	Moderate to Heavy	Severe	No	1390	52.0
42	Knox	90	C <sub>1</sub>	20	24	9°	Slight to Moderate	Moderate to Heavy	Severe	No	1029	53.4
43	Kosciusko	90	A	30	36	1°	Slight to Moderate	Moderate to Heavy	Severe	Yes	1450	49.0
44	LaGrange	90	A	30	36	1°	Slight to Moderate	Moderate to Heavy	Severe	Yes	1360	47.9
45	Lake	90	B	30	36	1°	Slight to Moderate	Moderate to Heavy	Severe	Yes	1300	49.0
46	LaPorte	90	A	30	36	1°	Slight to Moderate	Moderate to Heavy	Severe	Yes	1395	49.7
47	Lawrence	90	C	20	24	9°	Slight to Moderate	Moderate to Heavy	Severe	No	1115	52.6
48	Madison	90	B	20	30	2°	Slight to Moderate	Moderate to Heavy	Severe	No	1420	50.8
49	Marion	90	B	20	30	2°	Slight to Moderate	Moderate to Heavy	Severe	No	1215	51.8
50	Marshall	90	A	30	36	1°	Slight to Moderate	Moderate to Heavy	Severe	Yes	1424	50.0
51	Martin	90	C	20	24	9°	Slight to Moderate	Moderate to Heavy	Severe	No	849	54.2
52	Miami	90	A	20	36	1°	Slight to Moderate	Moderate to Heavy	Severe	Yes	1425	49.4
53	Monroe	90	C	20	24	9°	Slight to Moderate	Moderate to Heavy	Severe	No	1075	53.1
54	Montgomery	90	B	20	30	2°	Slight to Moderate	Moderate to Heavy	Severe	No	1435	50.1
55	Morgan	90	B	20	30	2°	Slight to Moderate	Moderate to Heavy	Severe	No	1200	51.5
56	Newton	90	B	30	36	1°	Slight to Moderate	Moderate to Heavy	Severe	Yes	1399	50.2
57	Noble	90	A	30	36	1°	Slight to Moderate	Moderate to Heavy	Severe	Yes	1375	49.0
58	Ohio	90	B	20	24	9°	Slight to Moderate	Moderate to Heavy	Severe	No	800	53.0
59	Orange	90	C	20	24	9°	Slight to Moderate	Moderate to Heavy	Severe	No	988	53.0
60	Owen	90	C	20	24	9°	Slight to Moderate	Moderate to Heavy	Severe	No	1224	50.1
61	Parke	90	B	20	30	2°	Slight to Moderate	Moderate to Heavy	Severe	No	1109	53.9
62	Perry	90	C	20	24	9°	Slight to Moderate	Moderate to Heavy	Severe	No	731	55.8
63	Pike	90	C <sub>1</sub>	20	24	9°	Slight to Moderate	Moderate to Heavy	Severe	No	810	54.8
64	Porter	90	B	30	36	1°	Slight to Moderate	Moderate to Heavy	Severe	Yes	1396	49.6

ONE AND TWO FAMILY DWELLING CODE

65 Posey	90	C <sub>1</sub>	20	24	9°	Slight to Moderate	Moderate to Heavy	Severe	No	867	55.4
66 Pulaski	90	A	30	36	1°	Slight to Moderate	Moderate to Heavy	Severe	Yes	1480	49.7
67 Putnam	90	B	20	30	2°	Slight to Moderate	Moderate to Heavy	Severe	No	1121	52.6
68 Randolph	90	B	20	30	2°	Slight to Moderate	Moderate to Heavy	Severe	No	1398	49.9
69 Ripley	90	B	20	24	9°	Slight to Moderate	Moderate to Heavy	Severe	No	820	54.5
70 Rush	90	B	20	30	2°	Slight to Moderate	Moderate to Heavy	Severe	No	1369	51.2
71 St. Joseph	90	A	30	36	1°	Slight to Moderate	Moderate to Heavy	Severe	Yes	1379	49.1
72 Scott	90	B	20	24	9°	Slight to Moderate	Moderate to Heavy	Severe	No	941	53.9
73 Shelby	90	B	20	30	2°	Slight to Moderate	Moderate to Heavy	Severe	No	1393	52.6
74 Spencer	90	C <sub>1</sub>	20	24	9°	Slight to Moderate	Moderate to Heavy	Severe	No	710	56.2
75 Starke	90	A	30	36	1°	Slight to Moderate	Moderate to Heavy	Severe	Yes	1425	49.7
76 Steuben	90	A	30	36	1°	Slight to Moderate	Moderate to Heavy	Severe	Yes	1370	47.3
77 Sullivan	90	C <sub>1</sub>	20	24	9°	Slight to Moderate	Moderate to Heavy	Severe	No	1090	52.7
78 Switzerland	90	B	20	24	9°	Slight to Moderate	Moderate to Heavy	Severe	No	727	55.7
79 Tippecanoe	90	B	20	30	2°	Slight to Moderate	Moderate to Heavy	Severe	No	1557	50.9
80 Tipton	90	B	20	30	2°	Slight to Moderate	Moderate to Heavy	Severe	No	1420	49.2
81 Union	90	B	20	30	2°	Slight to Moderate	Moderate to Heavy	Severe	No	1350	51.5
82 Vanderburgh	90	C <sub>1</sub>	20	24	9°	Slight to Moderate	Moderate to Heavy	Severe	No	581	57.0
83 Vermillion	90	B	20	30	2°	Slight to Moderate	Moderate to Heavy	Severe	No	1100	50.8
84 Vigo	90	C	20	24	9°	Slight to Moderate	Moderate to Heavy	Severe	No	1198	53.1
85 Wabash	90	A	20	36	1°	Slight to Moderate	Moderate to Heavy	Severe	Yes	1536	49.0
86 Warren	90	B	20	30	2°	Slight to Moderate	Moderate to Heavy	Severe	No	1400	51.0
87 Warrick	90	C <sub>1</sub>	20	24	9°	Slight to Moderate	Moderate to Heavy	Severe	No	690	56.2
88 Washington	90	B	20	24	9°	Slight to Moderate	Moderate to Heavy	Severe	No	950	54.5

ONE AND TWO FAMILY DWELLING CODE

89	Wayne	90	B	20	30	2°	Slight to Moderate	Moderate to Heavy	Severe	No	1383	49.9
90	Wells	90	B	20	36	1°	Slight to Moderate	Moderate to Heavy	Severe	Yes	1295	49.9
91	White	90	B	20	36	1°	Slight to Moderate	Moderate to Heavy	Severe	Yes	1410	50.3
92	Whitley	90	A	20	36	1°	Slight to Moderate	Moderate to Heavy	Severe	Yes	1493	48.8

<sup>1</sup>Wind exposure category shall be determined on a site-specific basis in accordance with SECTION R301.2.1.4.

<sup>2</sup>See SECTION R301.2.2.

<sup>3</sup>Foundation is minimum foundation depth to bottom of footing from the top of the finished grade above the footing in inches.

<sup>4</sup>The grade of masonry units shall be determined from ASTM C34, C55, C62, C73, C90, C129, C216, or C652.

*(Fire Prevention and Building Safety Commission; 675 IAC 14-4.3-6; filed Jun 13, 2005, 3:00 p.m.: 28 IR 3259, eff 90 days after filing with the Secretary of State)*

**675 IAC 14-4.3-7      Figures R301.2(1), R301.2(2), R301.2(3), R301.2(4), R301.2(5), R301.2(6), R301.2(7), and R301.2(8)**

Authority: IC 22-13-2-2; IC 22-13-2-13

Affected: IC 22-12; IC 22-13; IC 22-14; IC 22-15; IC 36-7

Sec. 7. Delete Figures R301.2(1), R301.2(2), R301.2(3), R301.2(4), R301.2(5), R301.2(6), R301.2(7), and R301.2(8). *(Fire Prevention and Building Safety Commission; 675 IAC 14-4.3-7; filed Jun 13, 2005, 3:00 p.m.: 28 IR 3262, eff 90 days after filing with the Secretary of State)*

**675 IAC 14-4.3-8      Table R301.2.1.2**

Authority: IC 22-13-2-2; IC 22-13-2-13

Affected: IC 22-12; IC 22-13; IC 22-14; IC 22-15; IC 36-7

Sec. 8. Delete Table R301.2.1.2 and the corresponding footnotes. *(Fire Prevention and Building Safety Commission; 675 IAC 14-4.3-8; filed Jun 13, 2005, 3:00 p.m.: 28 IR 3262, eff 90 days after filing with the Secretary of State)*

**675 IAC 14-4.3-9      Section R301.2.2; seismic provisions**

Authority: IC 22-13-2-2; IC 22-13-2-13

Affected: IC 22-12; IC 22-13; IC 22-14; IC 22-15; IC 36-7

Sec. 9. Change SECTION R301.2.2 to read as follows: The seismic provisions of this code shall apply to buildings constructed in Seismic Design Categories C and C<sub>1</sub> as determined in accordance with this section.

EXCEPTIONS: 1. Detached one and two family dwellings located in Seismic Design Category C are exempt from the seismic requirements of this code.

2. Detached one and two family dwellings located in Seismic Design Category C<sub>1</sub> shall comply with the following sections: R301.2.2.1.1, R301.2.2.3, R403.1.3, R403.1.4, R404.1.1, R404.1.2, R404.1.5, R606.10, R607.1.2, R611, R703.7, R1003.3, R1003.4, M2005.5, and FIGURE R606.10(2).

*(Fire Prevention and Building Safety Commission; 675 IAC 14-4.3-9; filed Jun 13, 2005, 3:00 p.m.: 28 IR 3263, eff 90 days after filing with the Secretary of State)*

**675 IAC 14-4.3-10      Section R301.2.2.1; determination of seismic design category**

Authority: IC 22-13-2-2; IC 22-13-2-13

Affected: IC 22-12; IC 22-13; IC 22-14; IC 22-15; IC 36-7

Sec. 10. Delete SECTION R301.2.2.1. *(Fire Prevention and Building Safety Commission; 675 IAC 14-4.3-10; filed Jun 13, 2005, 3:00 p.m.: 28 IR 3263, eff 90 days after filing with the Secretary of State)*

**675 IAC 14-4.3-11 Section R301.2.2.1.1; alternate determination of seismic design category**

Authority: IC 22-13-2-2; IC 22-13-2-13

Affected: IC 22-12; IC 22-13; IC 22-14; IC 22-15; IC 36-7

Sec. 11. Change SECTION R301.2.2.1.1 as follows: (a) Change the first sentence to read as follows: The Seismic Design Categories and corresponding Short Period Design Spectral Response Accelerations,  $S_{DS}$ , are based on soil Site Class D, as defined in the Indiana Building Code, 675 IAC 13.

(b) Change the second sentence to read as follows: If soil conditions are other than Site Class D, the Short Period Design Spectral Response Acceleration,  $S_{DS}$ , for a site can be determined according to the Indiana Building Code, 675 IAC 13.

(c) Change the third sentence to read as follows: The value of  $S_{DS}$  determined according to the Indiana Building Code, 675 IAC 13, is permitted to be used to set the Seismic Design Category according to TABLE R301.2.2.1.1, and to interpolate between values in TABLES R602.10.3 and R603.7 and other seismic design requirements of this code. *(Fire Prevention and Building Safety Commission; 675 IAC 14-4.3-11; filed Jun 13, 2005, 3:00 p.m.: 28 IR 3263, eff 90 days after filing with the Secretary of State)*

**675 IAC 14-4.3-12 Section R301.2.2.1.2; alternative determination of seismic design category E**

Authority: IC 22-13-2-2; IC 22-13-2-13

Affected: IC 22-12; IC 22-13; IC 22-14; IC 22-15; IC 36-7

Sec. 12. Delete SECTION R301.2.2.1.2. *(Fire Prevention and Building Safety Commission; 675 IAC 14-4.3-12; filed Jun 13, 2005, 3:00 p.m.: 28 IR 3263, eff 90 days after filing with the Secretary of State)*

**675 IAC 14-4.3-13 Section R301.2.2.2; seismic limitations**

Authority: IC 22-13-2-2; IC 22-13-2-13

Affected: IC 22-12; IC 22-13; IC 22-14; IC 22-15; IC 36-7

Sec. 13. Delete SECTION R301.2.2.2. *(Fire Prevention and Building Safety Commission; 675 IAC 14-4.3-13; filed Jun 13, 2005, 3:00 p.m.: 28 IR 3263, eff 90 days after filing with the Secretary of State)*

**675 IAC 14-4.3-14 Section R301.2.2.2.2; irregular buildings**

Authority: IC 22-13-2-2; IC 22-13-2-13

Affected: IC 22-12; IC 22-13; IC 22-14; IC 22-15; IC 36-7

Sec. 14. Delete SECTION R301.2.2.2.2. *(Fire Prevention and Building Safety Commission; 675 IAC 14-4.3-14; filed Jun 13, 2005, 3:00 p.m.: 28 IR 3263, eff 90 days after filing with the Secretary of State)*

**675 IAC 14-4.3-15 Section R301.2.2.3; Seismic Design Category C**

Authority: IC 22-13-2-2; IC 22-13-2-13

Affected: IC 22-12; IC 22-13; IC 22-14; IC 22-15; IC 36-7

Sec. 15. Make the following changes to SECTION R301.2.2.3: (a) Add “and  $C_1$ ” to the title.

(b) Add “and  $C_1$ ” after “Category C” in the text. *(Fire Prevention and Building Safety Commission; 675 IAC 14-4.3-15; filed Jun 13, 2005, 3:00 p.m.: 28 IR 3263, eff 90 days after filing with the Secretary of State)*

**675 IAC 14-4.3-16 Section R301.2.4; flood plain construction**

Authority: IC 22-13-2-2; IC 22-13-2-13

Affected: IC 22-12; IC 22-13; IC 22-14; IC 22-15; IC 36-7

Sec. 16. Delete SECTION R301.2.4 and substitute to read as follows: See local ordinance for flood plain construction. *(Fire Prevention and Building Safety Commission; 675 IAC 14-4.3-16; filed Jun 13, 2005, 3:00 p.m.: 28 IR 3263, eff 90 days after filing with the Secretary of State)*

**675 IAC 14-4.3-17 Section R301.5; live load**

Authority: IC 22-13-2-2; IC 22-13-2-13

Affected: IC 22-12; IC 22-13; IC 22-14; IC 22-15; IC 36-7

Sec. 17. Add a subsection to SECTION R301.5 to read as follows: R301.5.1 Live Load Reduction.

1. Tributary floor area. A structural member which supports a tributary floor area of greater than 200 square feet on a given story is permitted to be designed using a reduced uniform floor live load for each qualifying story in accordance with the following formula:

$$L = L_0 \left[ 0.25 + \frac{10.6}{\sqrt{A_t}} \right] \geq 0.75 \text{ for } A_t > 200 \text{ ft}^2$$

Where:  $A_t$  is the tributary area of floor surface in square feet supported by the structural member and  $L_0$  is the floor live load from TABLE R301.5.

2. Multiple stories. When floor, roof, and attic live loads from multiple story levels are applied to a structural member, the live loads may be factored as follows:

$$L = L_1 + 0.7(L_2 + L_3 + \dots)$$

Where:  $L_1$  is the live load from TABLES R301.5 and R301.6 producing the maximum individual load effect, and  $L_2, L_3,$  and so forth are live loads from other sources or stories in accordance with TABLES R301.5 and R301.6

*(Fire Prevention and Building Safety Commission; 675 IAC 14-4.3-17; filed Jun 13, 2005, 3:00 p.m.: 28 IR 3263, eff 90 days after filing with the Secretary of State)*

**675 IAC 14-4.3-18 Table R301.5; minimum uniformly distributed live loads**

Authority: IC 22-13-2-2; IC 22-13-2-13

Affected: IC 22-12; IC 22-13; IC 22-14; IC 22-15; IC 36-7

Sec. 18. Delete TABLE R301.5 and the corresponding footnotes and substitute to read as follows:

TABLE R301.5

MINIMUM UNIFORMLY DISTRIBUTED LIVE LOADS

USE	LIVE LOAD (pounds per square foot)
Attics–nonaccessible <sup>1</sup>	0
Attics–accessible <sup>2</sup>	10
Attics–uninhabitable <sup>3</sup>	20
Attics–inhabitable <sup>4</sup>	30 <sup>5</sup>
Balconies–exterior	60
Decks	40
Rooms other than sleeping rooms	40
Fire escapes	40
Garages <sup>6, 8</sup>	50
Guards and handrails <sup>9</sup>	200
Sleeping rooms	30
Stairs	40/300 <sup>7</sup>

<sup>1</sup>Attics where attic access is not required by SECTION R807.

<sup>2</sup>Attics where attic access is provided as required by SECTION R807 and a disappearing stairway or a permanent stairway is not provided. This load shall be noncurrent with any other load.

<sup>3</sup>Attic spaces having a minimum clear height greater than 6 feet and are not capable of containing the prism described in footnote 4 and are served by a disappearing or a permanent stairway.

<sup>4</sup>Attic spaces that are capable of containing a rectangular prism 7 feet high by 6 feet wide by 8 feet long free of any structural member.



<sup>5</sup>For trusses, the 30 pounds per square foot live load shall be applied over the entire length of the truss panel that contains the prism required by footnote 4.

<sup>6</sup>Passenger cars only.

<sup>7</sup>Individual stair treads shall be designed for the uniformly distributed live load of 40 pounds per square foot or a 300 pound concentrated load acting over an area of 4 square inches, whichever produces the greater stress.

<sup>8</sup>Elevated garage floors shall be capable of supporting a 2,000 pound load applied over a 20 square inch area.

<sup>9</sup>A single concentrated load applied in any direction at any point along the top.

*(Fire Prevention and Building Safety Commission; 675 IAC 14-4.3-18; filed Jun 13, 2005, 3:00 p.m.: 28 IR 3264, eff 90 days after filing with the Secretary of State)*

**675 IAC 14-4.3-19 Section R302.1; exterior walls**

Authority: IC 22-13-2-2; IC 22-13-2-13

Affected: IC 22-12; IC 22-13; IC 22-14; IC 22-15; IC 36-7

Sec. 19. Change SECTION R302.1 as follows: (a) Delete the last sentence of the first paragraph and the first exception without substitution.

(b) Delete the exception to the second paragraph and substitute to read as follows:

EXCEPTIONS: 1. Tool and storage sheds, playhouses, and similar structures are not required to provide wall protection based on location on the lot. Projections beyond the exterior of the structure shall not extend over the lot line.

2. Where structures are placed closer than 3 feet to the property lines, the one-hour fire-resistive rating shall not apply if a perpetual, platted, and recorded easement creates a nonbuildable separation of at least 6 feet between structures on adjacent properties.

*(Fire Prevention and Building Safety Commission; 675 IAC 14-4.3-19; filed Jun 13, 2005, 3:00 p.m.: 28 IR 3264, eff 90 days after filing with the Secretary of State)*

**675 IAC 14-4.3-20 Section R302.2; openings**

Authority: IC 22-13-2-2; IC 22-13-2-13

Affected: IC 22-12; IC 22-13; IC 22-14; IC 22-15; IC 36-7

Sec. 20. Add Exception 3 to the end of SECTION R302.2 to read as follows: 3. Where structures are placed closer than 3 feet to the property line, the limitation on openings in exterior walls shall not apply if a perpetual, platted, and recorded easement creates a nonbuildable separation of at least 6 feet between structures on adjacent properties. *(Fire Prevention and Building Safety Commission; 675 IAC 14-4.3-20; filed Jun 13, 2005, 3:00 p.m.: 28 IR 3264, eff 90 days after filing with the Secretary of State)*

**675 IAC 14-4.3-21 Section R303.1; habitable rooms**

Authority: IC 22-13-2-2; IC 22-13-2-13

Affected: IC 22-12; IC 22-13; IC 22-14; IC 22-15; IC 36-7

Sec. 21. Delete the third sentence of SECTION R303.1. *(Fire Prevention and Building Safety Commission; 675 IAC 14-4.3-21; filed Jun 13, 2005, 3:00 p.m.: 28 IR 3265, eff 90 days after filing with the Secretary of State)*

**675 IAC 14-4.3-22 Section R303.4.2; exhaust openings**

Authority: IC 22-13-2-2; IC 22-13-2-13

Affected: IC 22-12; IC 22-13; IC 22-14; IC 22-15; IC 36-7

Sec. 22. Delete SECTION R303.4.2. *(Fire Prevention and Building Safety Commission; 675 IAC 14-4.3-22; filed Jun 13, 2005, 3:00 p.m.: 28 IR 3265, eff 90 days after filing with the Secretary of State)*

**675 IAC 14-4.3-23 Section R303.6; stairway illumination**

Authority: IC 22-13-2-2; IC 22-13-2-13

Affected: IC 22-12; IC 22-13; IC 22-14; IC 22-15; IC 36-7

Sec. 23. In the first paragraph, delete everything after the first sentence and substitute to read as follows: For interior stairs the artificial light source shall be capable of illuminating treads and landings to levels not less than 1 foot-candle (11 lux) measured at the center of treads and landings. Exterior stairways shall be provided with an artificial light source located so that the top landing of the stairway is illuminated. Exterior stairways providing access to a basement from the outside grade level shall be provided with an artificial light source located so that the bottom landing of the stairway is illuminated. *(Fire Prevention and Building Safety Commission; 675 IAC 14-4.3-23; filed Jun 13, 2005, 3:00 p.m.: 28 IR 3265, eff 90 days after filing with the Secretary of State)*

**675 IAC 14-4.3-24 Section R305.1; minimum height**

Authority: IC 22-13-2-2; IC 22-13-2-13

Affected: IC 22-12; IC 22-13; IC 22-14; IC 22-15; IC 36-7

Sec. 24. Change Exception 4 to SECTION R305.1 to read as follows: Bathrooms shall have a minimum of 6 feet 8 inches (2,036 mm) at the center of the front clearance area for fixtures as shown in Figure R307.2. Ceiling height above fixtures shall be such that the fixture may be used for its intended purpose. A shower or tub equipped with a showerhead shall have a minimum ceiling height of 6 feet 8 inches (2,036 mm) above a minimum area 30 inches (762 mm) by 30 inches (762 mm) at the showerhead. *(Fire Prevention and Building Safety Commission; 675 IAC 14-4.3-24; filed Jun 13, 2005, 3:00 p.m.: 28 IR 3265, eff 90 days after filing with the Secretary of State)*

**675 IAC 14-4.3-25 Section R308.4; hazardous locations**

Authority: IC 22-13-2-2; IC 22-13-2-13

Affected: IC 22-12; IC 22-13; IC 22-14; IC 22-15; IC 36-7

Sec. 25. Make the following change to SECTION R308.4: Change Exception 5 to read as follows: 5. Glazing in SECTION 308.4, Item 6, when a protective bar is installed on the accessible sides of the glazing 34 inches (864 mm) to 38 inches (965 mm) above the floor. The bar shall be capable of withstanding a horizontal load of 50 pounds (22.68 kg) per linear foot without contacting the glass and be a minimum of 1½ inches (38 mm) in height. *(Fire Prevention and Building Safety Commission; 675 IAC 14-4.3-25; filed Jun 13, 2005, 3:00 p.m.: 28 IR 3265, eff 90 days after filing with the Secretary of State)*

**675 IAC 14-4.3-26 Section R309; garages and carports**

Authority: IC 22-13-2-2; IC 22-13-2-13

Affected: IC 22-12; IC 22-13; IC 22-14; IC 22-15; IC 36-7

Sec. 26. Change the title and text of SECTION R309 as follows: (a) Change the title of SECTION R309 to read as follows: GARAGES, CARPORTS, OR ACCESSORY STRUCTURES.

(b) Change the text of SECTION R309.2 to read as follows: The garage shall be separated from the residence and its attic area by a smoke separation of not less than ½ inch (13 mm) gypsum board applied to the garage side of the framing.

EXCEPTION: Pull down stairs may be installed in garage/attic separations when installed in a manner that resists the passage of smoke.

(c) Change the second paragraph of SECTIONS R309.3 and R309.4 to read as follows: The area of floor used for parking of automobiles or other vehicles shall be sloped to facilitate the movement of liquids to an approved drain or toward the main vehicle entry doorway.

(d) Delete the title and text of SECTION R309.5, Flood hazard areas, and substitute to read as follows: R309.5 Detached garages, carports, or accessory structures. R309.5.1 Separation. Detached garages, carports, or accessory structures shall provide not less than 6 feet of open space between same and the residence, except that such space may be roofed in compliance with Chapters 8 and 9 of this code. Detached garages, carports, or accessory structures separated from the residence by less than 6 feet of open space shall be considered the same as attached and shall comply with this code. In no case shall garages, carports, or accessory structures be attached to the dwelling when the footings of the structure to be attached are above the frost line and the adjacent

ONE AND TWO FAMILY DWELLING CODE

footings of the dwelling are at or below the frost line unless approved by the building official.

R309.5.2 Requirements. Detached garages, detached carports, or accessory structures shall be constructed to applicable sections of this code unless otherwise noted in TABLE R309. Any habitable rooms(s) located within a detached garage, detached carport, or accessory structure shall meet all applicable sections of this code and shall be provided with an exit door as specified in SECTION R311.1.

(e) Add TABLE R309 at the end of SECTION R309 to read as follows:

TABLE R309

DETACHED GARAGES, DETACHED CARPORTS, OR ACCESSORY STRUCTURES

CONSTRUCTION REQUIREMENTS	Portable 200 Square Feet Maximum	Monolithic <sup>1</sup> Footings 721 Square Feet Maximum	Structures with Conventional Foundation
Footings and Foundations	No Requirements	8" W × 18" D <sup>2</sup> or 12" W × 12" D <sup>2</sup>	Indiana Residential Code
Floors	No Requirements	Indiana Residential Code	
Exterior Walls	No Requirements		
Girders and Headers	No Requirements		
Roof Systems	No Requirements		
Electrical Power Limits	One 20 Amp. Circuit		
Water Supply/Sanitation	Not Allowed	1	
Permanent Heat	Not Allowed	1	
Maximum Number of Stories	1	1 <sup>3</sup>	3

NOTES:

<sup>1</sup>In structures utilizing monolithic floor systems, the water and sanitation systems and permanent heating facilities may be installed when approved flexible connections are provided.

<sup>2</sup>6 × 6 - W2.9 × W2.9 welded wire fabric or equivalent is required when monolithic slab footing system is used.

<sup>3</sup>One story unless otherwise approved by the building official.

*(Fire Prevention and Building Safety Commission; 675 IAC 14-4.3-26; filed Jun 13, 2005, 3:00 p.m.: 28 IR 3265, eff 90 days after filing with the Secretary of State)*

**675 IAC 14-4.3-27 Section R310; emergency escape and rescue openings**

Authority: IC 22-13-2-2; IC 22-13-2-13

Affected: IC 22-12; IC 22-13; IC 22-14; IC 22-15; IC 36-7

Sec. 27. Change SECTION R310 as follows: (a) Change the first sentence of SECTION R310.1 to read as follows: Every sleeping room shall have at least one openable emergency escape and rescue opening.

(b) Delete the second sentence of SECTION R310.1 without substitution.

(c) In SECTION R310.1.2, change "24 inches (610 mm)" to "22 inches (559 mm)".

(d) Add SECTION R310.1.5 to read as follows: R310.1.5 Sleeping room replacement window alterations. When replacing existing sleeping room windows, at least one of the replacement windows within that sleeping room shall comply with SECTION R310.5. Replacement windows that do not meet the current emergency escape requirements of SECTION R310, without structural alterations to the dwelling, may be installed as long as they meet the following requirements.

1. Replacement window installation shall not reduce the existing net clear opening by more than 6 inches horizontally and 6 inches vertically, except that awning replacement windows shall not reduce the existing net clear opening by more than 3 inches vertically.

2. In no case shall the replacement window net clear opening height be less than 22 inches (559 mm) and the net clear opening width be less than 20 inches (508 mm).

3. Double hung or sliding replacement windows shall have both sashes removable without the use of a key or tool. Single hung installations are not allowed by this section.

4. Casement and awning replacement windows may obtain the required net clear opening with the use of egress hardware.

5. If the replacement window cannot meet the minimum requirements listed in subdivisions 1, 2, 3, and 4, the existing window

shall be replaced with a like window without reducing the existing net clear opening.  
*(Fire Prevention and Building Safety Commission; 675 IAC 14-4.3-27; filed Jun 13, 2005, 3:00 p.m.: 28 IR 3266, eff 90 days after filing with the Secretary of State)*

**675 IAC 14-4.3-28 Section R311.4.3; landings at doors**

Authority: IC 22-13-2-2; IC 22-13-2-13  
Affected: IC 22-12; IC 22-13; IC 22-14; IC 22-15; IC 36-7

Sec. 28. Make the following change to SECTION R311.4.3: In the exception to the second paragraph of SECTION R311.4.3, delete “7¼ inches (196 mm)” and substitute “8¼ inches (210 mm)”. *(Fire Prevention and Building Safety Commission; 675 IAC 14-4.3-28; filed Jun 13, 2005, 3:00 p.m.: 28 IR 3266, eff 90 days after filing with the Secretary of State)*

**675 IAC 14-4.3-29 Section R311.4.4; type of lock or latch**

Authority: IC 22-13-2-2; IC 22-13-2-13  
Affected: IC 22-12; IC 22-13; IC 22-14; IC 22-15; IC 36-7

Sec. 29. Delete “egress” between “all” and “doors” and delete “or special knowledge or effort” from SECTION R311.4.4. *(Fire Prevention and Building Safety Commission; 675 IAC 14-4.3-29; filed Jun 13, 2005, 3:00 p.m.: 28 IR 3267, eff 90 days after filing with the Secretary of State)*

**675 IAC 14-4.3-30 Section R311.5.3.1; riser height**

Authority: IC 22-13-2-2; IC 22-13-2-13  
Affected: IC 22-12; IC 22-13; IC 22-14; IC 22-15; IC 36-7

Sec. 30. In the first sentence of SECTION R311.5.3.1, delete “7¼ inches (196 mm)” and substitute “8¼ inches (210 mm)”. *(Fire Prevention and Building Safety Commission; 675 IAC 14-4.3-30; filed Jun 13, 2005, 3:00 p.m.: 28 IR 3267, eff 90 days after filing with the Secretary of State)*

**675 IAC 14-4.3-31 Section R311.5.3.2; tread depth**

Authority: IC 22-13-2-2; IC 22-13-2-13  
Affected: IC 22-12; IC 22-13; IC 22-14; IC 22-15; IC 36-7

Sec. 31. In the first and fourth sentences of SECTION R311.5.3.2, delete “10 inches (254 mm)” and substitute “9 inches (229 mm)”. *(Fire Prevention and Building Safety Commission; 675 IAC 14-4.3-31; filed Jun 13, 2005, 3:00 p.m.: 28 IR 3267, eff 90 days after filing with the Secretary of State)*

**675 IAC 14-4.3-32 Section R311.5.6.2; continuity**

Authority: IC 22-13-2-2; IC 22-13-2-13  
Affected: IC 22-12; IC 22-13; IC 22-14; IC 22-15; IC 36-7

Sec. 32. Change Exception 1 by adding the words “or by a landing” after “turn” and before the “.”. *(Fire Prevention and Building Safety Commission; 675 IAC 14-4.3-32; filed Jun 13, 2005, 3:00 p.m.: 28 IR 3267, eff 90 days after filing with the Secretary of State)*

**675 IAC 14-4.3-33 Section R311.5.6.3; handrail grip size**

Authority: IC 22-13-2-2; IC 22-13-2-13  
Affected: IC 22-12; IC 22-13; IC 22-14; IC 22-15; IC 36-7

Sec. 33. Delete the text of SECTION 311.5.6.3 and substitute to read as follows: The handrail grip size portion of handrails shall have a circular cross section of 1¼ inches (32 mm) minimum to 2⅞ inches (80 mm) maximum. Other handrail shapes that provide an equivalent grasping surface are permissible. Edges shall have a minimum radius of ⅛ inch (3.2 mm). *(Fire Prevention*

*and Building Safety Commission; 675 IAC 14-4.3-33; filed Jun 13, 2005, 3:00 p.m.: 28 IR 3267, eff 90 days after filing with the Secretary of State)*

**675 IAC 14-4.3-34 Section R311.5.8.1; bulkhead enclosure stairways**

Authority: IC 22-13-2-2; IC 22-13-2-13

Affected: IC 22-12; IC 22-13; IC 22-14; IC 22-15; IC 36-7

Sec. 34. Change, in SECTION R311.5.8.1, “egress” to “exit”. *(Fire Prevention and Building Safety Commission; 675 IAC 14-4.3-34; filed Jun 13, 2005, 3:00 p.m.: 28 IR 3267, eff 90 days after filing with the Secretary of State)*

**675 IAC 14-4.3-35 Section R312.1; guards required**

Authority: IC 22-13-2-2; IC 22-13-2-13

Affected: IC 22-12; IC 22-13; IC 22-14; IC 22-15; IC 36-7

Sec. 35. Change SECTION R312.1 as follows: (a) In the first sentence, add “, decks” between “balconies” and “or”.

(b) Add a sentence at the end of the section to read as follows: Guards that are installed on porches, balconies, decks, or raised floor surfaces that are 30 inches (762 mm) or less above the floor or grade are not required to comply with SECTION 312. *(Fire Prevention and Building Safety Commission; 675 IAC 14-4.3-35; filed Jun 13, 2005, 3:00 p.m.: 28 IR 3267, eff 90 days after filing with the Secretary of State)*

**675 IAC 14-4.3-36 Section R312.2; guard opening limitations**

Authority: IC 22-13-2-2; IC 22-13-2-13

Affected: IC 22-12; IC 22-13; IC 22-14; IC 22-15; IC 36-7

Sec. 36. Add in the first sentence of SECTION R316.2 “, decks” between “balconies” and “and”. *(Fire Prevention and Building Safety Commission; 675 IAC 14-4.3-36; filed Jun 13, 2005, 3:00 p.m.: 28 IR 3267, eff 90 days after filing with the Secretary of State)*

**675 IAC 14-4.3-37 Section R313; smoke alarms**

Authority: IC 22-13-2-2; IC 22-13-2-13; IC 22-11-18

Affected: IC 22-12; IC 22-13; IC 22-14; IC 22-15; IC 36-7

Sec. 37. Delete the text of SECTION R313 and substitute to read as follows: R313.1 Labeling. Each smoke alarm shall be listed:

R313.2 Required smoke alarm locations. At least one smoke alarm shall be installed in each of the following locations:

(a) In the living area remote from the kitchen and cooking appliances. Smoke alarms located within 20 feet (6.1 m) horizontally of a cooking appliance must incorporate a temporary silencing feature or be photoelectric type.

(b) In each room designed for sleeping.

(c) On the ceiling of the upper level near the top or above each stairway, other than a basement stairway, in any multistory dwelling. The alarm shall be located so that smoke rising in the stairway cannot be prevented from reaching the alarm by an intervening door or obstruction.

(d) On the basement ceiling near the stairway.

R313.2.1 Alterations and additions. When interior alterations or additions requiring a permit occur, or when one or more sleeping rooms are added or created in existing dwellings, the individual dwelling unit shall be provided with smoke alarms located as required for new dwellings; the smoke alarms shall be interconnected and hard wired.

EXCEPTIONS: 1. Smoke alarms in existing areas shall not be required to meet the requirements of R317.5 where the alterations do not result in the removal of the interior wall or ceiling finishes exposing the structure unless there is an attic, crawlspace, or basement available that could provide access for hard wiring and interconnection without the removal of interior finishes.

2. Repairs are exempt from the requirements of this section.

R313.3 Prohibited smoke alarm locations. A smoke alarm required under this section shall not be placed:

1. within 3 feet (914 mm) horizontally from any grille moving conditioned air within the living space; or
2. in any location or environment that is prohibited by the terms of the listing.

R313.4 Mounting requirements. Smoke alarms required by SECTION R313.2 shall be mounted in accordance with their listing, installation instructions, and the requirements of this section.

R313.4.1 Flat Ceilings. In rooms with flat, peaked sloping or single slope ceilings with a slope of less than 1.5/12, smoke alarms shall be mounted either:

1. on the ceiling at least 4 inches (102 mm) from each wall; or
2. on a wall with the top of the alarm not less than 4 inches (102 mm) below the ceiling and not farther from the ceiling than 12 inches (305 mm) or the distance from the ceiling specified in the smoke alarm manufacturer's listing and installation instructions, whichever is less.

R313.4.2 Peaked Sloping Ceilings. In rooms with peaked sloping ceilings with a slope of 1.5/12 or greater, smoke alarms shall be:

1. mounted on the ceiling or wall within 3 feet (914 mm) measured horizontally, from the peak of the ceiling;
2. at least 4 inches (102 mm), measured vertically, below the peak of the ceiling; and
3. at least 4 inches (102 mm) from any projecting structural element.

R313.4.3 Single Slope Ceilings. In rooms with single slope ceilings with a slope of 1.5/12 or greater, smoke alarms shall be:

1. mounted on the ceiling or wall within 3 feet (914 mm), measured horizontally, of the high point of the ceiling; and
2. not closer than 4 inches (102 mm) from any adjoining wall surfaces or any projecting structural element.

R313.4.4 Visible and tactile notification appliances. In addition to the smoke alarms required pursuant to this section, listed visible and tactile notification appliances, when installed, shall meet the following:

R313.4.4.1 Candela Rating-Sleeping Room. A visible notification appliance, when installed in a room designed for sleeping, shall have a minimum rating of 177 candela, except that when the visible notification appliance is wall-mounted or suspended more than 24 inches (610 mm) below the ceiling, a minimum rating of 110 candela is permitted.

R313.4.4.2 Candela Rating-Nonsleeping Room. A visible notification appliance, when installed in an area other than a room designed for sleeping, shall have a minimum rating of 15 candela.

R313.5 Connection to Power Source. Each smoke alarm shall be powered from:

1. the electrical system of the home as the primary power source and a battery as a secondary power source; or
2. a battery rated for a 10 year life, provided the smoke alarm is listed for use with a 10 year battery.

EXCEPTION: Visible and tactile notification appliances are required to operate from the primary power source but are not required to operate from a secondary power source.

R313.5.1 Circuitry. Each smoke alarm whose primary power source is the home electrical system shall be mounted on an electrical outlet box and be connected by a permanent wiring method to a general branch circuit. The same branch circuit may serve more than one smoke alarm. The branch circuit for the alarm shall not include any switches between the branch circuit overcurrent protective device and the alarm and shall not be protected by a ground-fault circuit-interrupter.

R313.5.2 Interconnection. When more than one smoke alarm is required to be installed within an individual dwelling unit, the alarm devices shall be interconnected in such a manner that the actuation of one alarm will activate all of the alarms in the individual unit. *(Fire Prevention and Building Safety Commission; 675 IAC 14-4.3-37; filed Jun 13, 2005, 3:00 p.m.: 28 IR 3267, eff 90 days after filing with the Secretary of State)*

**675 IAC 14-4.3-38 Section R314.2.3; attics and crawlspaces**

Authority: IC 22-13-2-2; IC 22-13-2-13

Affected: IC 22-12; IC 22-13; IC 22-14; IC 22-15; IC 36-7

Sec. 38. Delete SECTION R314.2.3 and substitute to read as follows: Within an attic or crawlspace, foam plastics shall be protected against ignition by 1½ inch thick mineral fiber insulation, or ¼ inch thick plywood, or ¾ inch particleboard, or ¼ inch hardboard, or ¾ inch gypsum wallboard or corrosion-resistant steel having a base metal thickness of 0.016 inch or other approved material installed in such a manner that the foam plastic is not exposed.

EXCEPTION: Foam plastic insulation may be installed on the walls of attics and crawlspaces with no covering applied provided all the following conditions are met:

1. The maximum thickness/density is within the following:
  - a. Maximum 4 inch thickness with a maximum density of 4.0 pcf.
  - b. Up to 2 inch thickness with a maximum density of 2.5 pcf.

- c. Up to 1 inch thickness with a maximum density of 2.0 pcf.
2. The maximum flame spread is 25.
3. The maximum smoke development rating is 450.
4. The entry to the attic or crawlspace is made only for service or maintenance (not used for storage).
5. There are not interconnected basement areas.
6. The air in the attic or crawlspace is not circulated to other parts of the building.
7. Where fuel-burning appliances other than direct vent appliances or exposed (not sealed) motors are located more than 10 feet away from the foam insulation in the attic or crawlspace.

*(Fire Prevention and Building Safety Commission; 675 IAC 14-4.3-38; filed Jun 13, 2005, 3:00 p.m.: 28 IR 3268, eff 90 days after filing with the Secretary of State)*

**675 IAC 14-4.3-39 Section R317.3.2; membrane penetrations**

Authority: IC 22-13-2-2; IC 22-13-2-13

Affected: IC 22-12; IC 22-13; IC 22-14; IC 22-15; IC 36-7

Sec. 39. In SECTION R317.3.2, change Exceptions 1 and 2 by deleting “as follows:” and substituting “by any of the following:”. *(Fire Prevention and Building Safety Commission; 675 IAC 14-4.3-39; filed Jun 13, 2005, 3:00 p.m.: 28 IR 3269, eff 90 days after filing with the Secretary of State)*

**675 IAC 14-4.3-40 Section R318.1; moisture control**

Authority: IC 22-13-2-2; IC 22-13-2-13

Affected: IC 22-12; IC 22-13; IC 22-14; IC 22-15; IC 36-7

Sec. 40. Delete Exception 3 in SECTION R318.1 without substitution. *(Fire Prevention and Building Safety Commission; 675 IAC 14-4.3-40; filed Jun 13, 2005, 3:00 p.m.: 28 IR 3269, eff 90 days after filing with the Secretary of State)*

**675 IAC 14-4.3-41 Section R319.1; location required**

Authority: IC 22-13-2-2; IC 22-13-2-13

Affected: IC 22-12; IC 22-13; IC 22-14; IC 22-15; IC 36-7

Sec. 41. Add a sentence at the end of Item 2 of SECTION 319.1 to read as follows: Minimum height of foundation walls above finish grade are as established in R404.1.6. *(Fire Prevention and Building Safety Commission; 675 IAC 14-4.3-41; filed Jun 13, 2005, 3:00 p.m.: 28 IR 3269, eff 90 days after filing with the Secretary of State)*

**675 IAC 14-4.3-42 Section R319.1.2; R319.1; location required**

Authority: IC 22-13-2-2; IC 22-13-2-13

Affected: IC 22-12; IC 22-13; IC 22-14; IC 22-15; IC 36-7

Sec. 42. (a) Change Item 3 to read as follows: Sills and sleepers on a concrete or masonry slab that is in direct contact with the ground unless separated from such slab by an impervious moisture barrier, or unless such slab is separated from the ground by a vapor retarder.

(b) Add an exception to SECTION R319.1, Item 7, to read as follows: EXCEPTION: Exterior walls, below grade complying with SECTION R406. *(Fire Prevention and Building Safety Commission; 675 IAC 14-4.3-42; filed Jun 13, 2005, 3:00 p.m.: 28 IR 3269, eff 90 days after filing with the Secretary of State)*

**675 IAC 14-4.3-43 Section R319.1.2; geographical areas**

Authority: IC 22-13-2-2; IC 22-13-2-13

Affected: IC 22-12; IC 22-13; IC 22-14; IC 22-15; IC 36-7

Sec. 43. Change SECTION R319.1.2 to read as follows: Approved naturally durable or pressure preservative treated wood shall be used for those portions of wood members that form the structural supports of buildings, balconies, decks, porches, or similar

permanent building appurtenances when such members are exposed to the weather without adequate protection from a roof, eave, overhang, or other covering that would prevent moisture or water accumulation on the surface or at joints between members. Such members may include the following:

1. Horizontal members, such as girders, joists, and decking.
2. Vertical members, such as posts, poles, and columns.
3. Both horizontal and vertical members.

*(Fire Prevention and Building Safety Commission; 675 IAC 14-4.3-43; filed Jun 13, 2005, 3:00 p.m.: 28 IR 3269, eff 90 days after filing with the Secretary of State)*

**675 IAC 14-4.3-44 Section R319.1.3; post, poles, and columns**

Authority: IC 22-13-2-2; IC 22-13-2-13

Affected: IC 22-12; IC 22-13; IC 22-14; IC 22-15; IC 36-7

Sec. 44. Delete, from SECTION R319.1.3, “approved pressure preservatively treated wood” without substitution. *(Fire Prevention and Building Safety Commission; 675 IAC 14-4.3-44; filed Jun 13, 2005, 3:00 p.m.: 28 IR 3269, eff 90 days after filing with the Secretary of State)*

**675 IAC 14-4.3-45 Section R319.2; quality mark**

Authority: IC 22-13-2-2; IC 22-13-2-13

Affected: IC 22-12; IC 22-13; IC 22-14; IC 22-15; IC 36-7

Sec. 45. Change, in SECTION R319.2, “approved by an accreditation body” to “accepted by an accreditation body”. *(Fire Prevention and Building Safety Commission; 675 IAC 14-4.3-45; filed Jun 13, 2005, 3:00 p.m.: 28 IR 3269, eff 90 days after filing with the Secretary of State)*

**675 IAC 14-4.3-46 Section R319.3; fasteners**

Authority: IC 22-13-2-2; IC 22-13-2-13

Affected: IC 22-12; IC 22-13; IC 22-14; IC 22-15; IC 36-7

Sec. 46. Delete the text of SECTION R319.3 and substitute to read as follows: Fasteners for pressure preservative treated wood shall be of G185 hot-dipped galvanized steel, stainless steel, silicon bronze, copper, or the requirements of the chemical manufacturer of the chemicals used in the treated wood. Except for borate treated wood, aluminum fasteners, hardware, or flashing shall not be in direct contact with pressure preservative treated wood. Fasteners for fire-retardant wood shall be of hot-dipped galvanized steel, stainless steel, silicon bronze, copper, or the requirements of the chemical manufacturer of the chemicals used in the treated wood. *(Fire Prevention and Building Safety Commission; 675 IAC 14-4.3-46; filed Jun 13, 2005, 3:00 p.m.: 28 IR 3270, eff 90 days after filing with the Secretary of State)*

**675 IAC 14-4.3-47 Section R320.1; subterranean termite control**

Authority: IC 22-13-2-2; IC 22-13-2-13

Affected: IC 22-12; IC 22-13; IC 22-14; IC 22-15; IC 36-7

Sec. 47. Delete “favorable to termite damage” and substitute “subject to very heavy termite damage”. *(Fire Prevention and Building Safety Commission; 675 IAC 14-4.3-47; filed Jun 13, 2005, 3:00 p.m.: 28 IR 3270, eff 90 days after filing with the Secretary of State)*

**675 IAC 14-4.3-48 Section R320.4; foam plastic protection**

Authority: IC 22-13-2-2; IC 22-13-2-13

Affected: IC 22-12; IC 22-13; IC 22-14; IC 22-15; IC 36-7

Sec. 48. Delete SECTION R320.4. *(Fire Prevention and Building Safety Commission; 675 IAC 14-4.3-48; filed Jun 13, 2005, 3:00 p.m.: 28 IR 3270, eff 90 days after filing with the Secretary of State)*



**675 IAC 14-4.3-49 Section R322; accessibility**

Authority: IC 22-13-2-2; IC 22-13-2-13

Affected: IC 22-12; IC 22-13; IC 22-14; IC 22-15; IC 36-7

Sec. 49. Delete SECTION R322. *(Fire Prevention and Building Safety Commission; 675 IAC 14-4.3-49; filed Jun 13, 2005, 3:00 p.m.: 28 IR 3270, eff 90 days after filing with the Secretary of State)*

**675 IAC 14-4.3-50 Section 323; flood-resistant construction**

Authority: IC 22-13-2-2; IC 22-13-2-13

Affected: IC 22-12; IC 22-13; IC 22-14; IC 22-15; IC 36-7

Sec. 50. Delete SECTION 323 FLOOD-RESISTANT CONSTRUCTION and substitute to read as follows: See local ordinance. *(Fire Prevention and Building Safety Commission; 675 IAC 14-4.3-50; filed Jun 13, 2005, 3:00 p.m.: 28 IR 3270, eff 90 days after filing with the Secretary of State)*

**675 IAC 14-4.3-51 Section 401.1; application**

Authority: IC 22-13-2-2; IC 22-13-2-13

Affected: IC 22-12; IC 22-13; IC 22-14; IC 22-15; IC 36-7

Sec. 51. Delete the exceptions in SECTION 401.1. *(Fire Prevention and Building Safety Commission; 675 IAC 14-4.3-51; filed Jun 13, 2005, 3:00 p.m.: 28 IR 3270, eff 90 days after filing with the Secretary of State)*

**675 IAC 14-4.3-52 Section R401.3; drainage**

Authority: IC 22-13-2-2; IC 22-13-2-13

Affected: IC 22-12; IC 22-13; IC 22-14; IC 22-15; IC 36-7

Sec. 52. Delete the first sentence of SECTION R401.3. *(Fire Prevention and Building Safety Commission; 675 IAC 14-4.3-52; filed Jun 13, 2005, 3:00 p.m.: 28 IR 3270, eff 90 days after filing with the Secretary of State)*

**675 IAC 14-4.3-53 Section R402.1.2; wood treatment**

Authority: IC 22-13-2-2; IC 22-13-2-13

Affected: IC 22-12; IC 22-13; IC 22-14; IC 22-15; IC 36-7

Sec. 53. Change, in the first sentence of SECTION R402.1.2, “accredited agency” to “approved agency”. *(Fire Prevention and Building Safety Commission; 675 IAC 14-4.3-53; filed Jun 13, 2005, 3:00 p.m.: 28 IR 3270, eff 90 days after filing with the Secretary of State)*

**675 IAC 14-4.3-54 Section R403.1; general**

Authority: IC 22-13-2-2; IC 22-13-2-13

Affected: IC 22-12; IC 22-13; IC 22-14; IC 22-15; IC 36-7

Sec. 54. Delete, in the first sentence of SECTION R403.1, “continuous”. *(Fire Prevention and Building Safety Commission; 675 IAC 14-4.3-54; filed Jun 13, 2005, 3:00 p.m.: 28 IR 3270, eff 90 days after filing with the Secretary of State)*

**675 IAC 14-4.3-55 Section R403.1.1; minimum size**

Authority: IC 22-13-2-2; IC 22-13-2-13

Affected: IC 22-12; IC 22-13; IC 22-14; IC 22-15; IC 36-7

Sec. 55. (a) In SECTION R403.1.1, delete the fifth sentence and substitute to read as follows: The minimum size of footings supporting piers and columns shall be in accordance with TABLE R403.2.

(b) Change TABLE R403.1 as follows:

(1) In the title add a reference to footnote “b” after the reference to footnote “a”.

(2) Add footnote “b” to read as follows: <sup>b</sup>A basement shall not be considered a story for the purpose of this table.

*(Fire Prevention and Building Safety Commission; 675 IAC 14-4.3-55; filed Jun 13, 2005, 3:00 p.m.: 28 IR 3270, eff 90 days after filing with the Secretary of State)*

**675 IAC 14-4.3-56 Section R403.1.2; continuous footings in seismic design categories D<sub>1</sub> and D<sub>2</sub>**

Authority: IC 22-13-2-2; IC 22-13-2-13

Affected: IC 22-12; IC 22-13; IC 22-14; IC 22-15; IC 36-7

Sec. 56. Delete SECTION R403.1.2. *(Fire Prevention and Building Safety Commission; 675 IAC 14-4.3-56; filed Jun 13, 2005, 3:00 p.m.: 28 IR 3271, eff 90 days after filing with the Secretary of State)*

**675 IAC 14-4.3-57 Section R403.1.3; seismic reinforcing**

Authority: IC 22-13-2-2; IC 22-13-2-13

Affected: IC 22-12; IC 22-13; IC 22-14; IC 22-15; IC 36-7

Sec. 57. (a) Delete the title and text of SECTION R403.1.3 and substitute to read as follows: Footings in Seismic Design Category C<sub>1</sub>. In Seismic Design Category C<sub>1</sub>, as a minimum requirement, 2 #4 bars shall be placed longitudinally in the bottom of the exterior footings.

(b) Add a sentence at the end of SECTION R403.1.3 to read as follows: The required bars shall be placed in the bottom half of the footing, at least 6 inches (152.4 mm) apart and not less than 3 inches (76.2 mm) from the bottom and the sides of the footing. *(Fire Prevention and Building Safety Commission; 675 IAC 14-4.3-57; filed Jun 13, 2005, 3:00 p.m.: 28 IR 3271, eff 90 days after filing with the Secretary of State)*

**675 IAC 14-4.3-58 Section R403.1.3.1; foundations with stemwalls**

Authority: IC 22-13-2-2; IC 22-13-2-13

Affected: IC 22-12; IC 22-13; IC 22-14; IC 22-15; IC 36-7

Sec. 58. Delete SECTION R403.1.3.1. *(Fire Prevention and Building Safety Commission; 675 IAC 14-4.3-58; filed Jun 13, 2005, 3:00 p.m.: 28 IR 3271, eff 90 days after filing with the Secretary of State)*

**675 IAC 14-4.3-59 Section R403.1.3.2; slabs-on-ground with turned-down footings**

Authority: IC 22-13-2-2; IC 22-13-2-13

Affected: IC 22-12; IC 22-13; IC 22-14; IC 22-15; IC 36-7

Sec. 59. Delete SECTION R403.1.3.2. *(Fire Prevention and Building Safety Commission; 675 IAC 14-4.3-59; filed Jun 13, 2005, 3:00 p.m.: 28 IR 3271, eff 90 days after filing with the Secretary of State)*

**675 IAC 14-4.3-60 Section R403.1.4.2; seismic conditions**

Authority: IC 22-13-2-2; IC 22-13-2-13

Affected: IC 22-12; IC 22-13; IC 22-14; IC 22-15; IC 36-7

Sec. 60. Change the text of SECTION R403.1.4.2 to read as follows: In Seismic Design Category C<sub>1</sub>, interior footings cast monolithically with a slab on grade shall extend to a depth of not less than 8 inches below the top of the slab or to the undisturbed ground or engineered fill, whichever is greater. *(Fire Prevention and Building Safety Commission; 675 IAC 14-4.3-60; filed Jun 13, 2005, 3:00 p.m.: 28 IR 3271, eff 90 days after filing with the Secretary of State)*

**675 IAC 14-4.3-61 Section R403.1.4.1; frost protection**

Authority: IC 22-13-2-2; IC 22-13-2-13

Affected: IC 22-12; IC 22-13; IC 22-14; IC 22-15; IC 36-7

Sec. 61. Delete the text of Exception 1 to SECTION 403.1.4.1 and substitute to read as follows: Detached garages, detached carports, or accessory structures built to the requirements of Table 309. *(Fire Prevention and Building Safety Commission; 675 IAC 14-4.3-61; filed Jun 13, 2005, 3:00 p.m.: 28 IR 3271, eff 90 days after filing with the Secretary of State)*

**675 IAC 14-4.3-62 Section R403.1.6; foundation anchorage**

Authority: IC 22-13-2-2; IC 22-13-2-13  
 Affected: IC 22-12; IC 22-13; IC 22-14; IC 22-15; IC 36-7

Sec. 62. Make the following changes to SECTION R403.1.6: (a) Change the fourth sentence of the second paragraph to read as follows: Bolts shall be at least ½ inch (13 mm) in diameter and shall extend a minimum 7 inches (178 mm) into the core, cell, or joint of the masonry unit and 7 inches (178 mm) into concrete.

(b) Change the fifth sentence to read as follows: Interior bearing wall sole plates on monolithic slab foundations shall be positively anchored with anchor bolts or approved fasteners in accordance with the manufacturer’s instructions. *(Fire Prevention and Building Safety Commission; 675 IAC 14-4.3-62; filed Jun 13, 2005, 3:00 p.m.: 28 IR 3271, eff 90 days after filing with the Secretary of State)*

**675 IAC 14-4.3-63 Section R403.1.7.3; foundation elevation**

Authority: IC 22-13-2-2; IC 22-13-2-13  
 Affected: IC 22-12; IC 22-13; IC 22-14; IC 22-15; IC 36-7

Sec. 63. Delete SECTION R403.1.7.3. *(Fire Prevention and Building Safety Commission; 675 IAC 14-4.3-63; filed Jun 13, 2005, 3:00 p.m.: 28 IR 3271, eff 90 days after filing with the Secretary of State)*

**675 IAC 14-4.3-64 Section R403.1.7.4; alternate setback and clearances**

Authority: IC 22-13-2-2; IC 22-13-2-13  
 Affected: IC 22-12; IC 22-13; IC 22-14; IC 22-15; IC 36-7

Sec. 64. Delete the second sentence of SECTION R403.1.7.4. *(Fire Prevention and Building Safety Commission; 675 IAC 14-4.3-64; filed Jun 13, 2005, 3:00 p.m.: 28 IR 3271, eff 90 days after filing with the Secretary of State)*

**675 IAC 14-4.3-65 Section R403.1.8; foundations on expansive soils**

Authority: IC 22-13-2-2; IC 22-13-2-13  
 Affected: IC 22-12; IC 22-13; IC 22-14; IC 22-15; IC 36-7

Sec. 65. Change SECTION R403.1.8 to read as follows: Foundation and floor slabs for buildings located on expansive soils shall be designed in accordance with the Indiana Building Code (675 IAC 13). *(Fire Prevention and Building Safety Commission; 675 IAC 14-4.3-65; filed Jun 13, 2005, 3:00 p.m.: 28 IR 3271, eff 90 days after filing with the Secretary of State)*

**675 IAC 14-4.3-66 Table R403.2; size of footings supporting piers and columns**

Authority: IC 22-13-2-2; IC 22-13-2-13  
 Affected: IC 22-12; IC 22-13; IC 22-14; IC 22-15; IC 36-7

Sec. 66. Add TABLE R403.2 to read as follows:

TABLE R403.2  
 SIZE OF FOOTINGS SUPPORTING PIERS AND COLUMNS

Spacing of Girder “S” <sup>1</sup>	Type of Loading <sup>2</sup>			Column Size Required <sup>3</sup>		Size of Plain Concrete Footing Required <sup>3</sup>
	A	B	C	Steel	Wood	
10’	5’-6”	—	—	3”	4” × 4”	2’ × 2’ × 8” <sup>c</sup>
15’	4’-0”	—	—	Steel		
20’	—	—	—	Pipe <sup>4</sup>		

**ONE AND TWO FAMILY DWELLING CODE**

10'	8'-6"	5'-0"	-		
15'	6'-0"	4'-0"	-		
20'	4'-6"	-	-		
10'	12'-0"	9'-0"	8'-0"	6" × 6"	4' × 4' × 16" <sup>5</sup>
15'	10'-0"	8'-0"	7'-0"		
20'	8'-0"	7'-0"	6'-0"		
10'	16'-0"	12'-6"	11'-0"	8" × 8"	4'3" × 4'3" × 17" <sup>5</sup>
15'	13'-6"	10'-6"	10'-0"		
20'	12'-0"	9'-6"	8'-0"		
10'	20'-0"	16'-0"	13'-6"		
15'	17'-0"	13'-6"	11'-6"		
20'	15'-0"	12'-0"	10'-0"		

<sup>1</sup>The spacing "S" is the tributary load in the girder. It is found by adding the unsupported spans of the floor joists on each side that are supported by the girder and dividing by 2.

<sup>2</sup>Figures under type of loading columns are the allowable girder span.

Type A loading is for a girder supporting 1 floor and a roof.

Type B loading is for a girder supporting 2 floors and a roof.

Type C loading is for a girder supporting 3 floors and a roof.

<sup>3</sup>Required size of column is based on girder support from 2 sides. Size of footing is based on allowable soil pressure of 2,000 pounds per square foot.

<sup>4</sup>Schedule 40.

<sup>5</sup>Footing thickness is based on the use of plain concrete with an ultimate compressive strength of not less than 2,000 pounds per square inch at 28 days. If approved, the footing thickness may be reduced based on an engineered design utilizing higher strength concrete and/or reinforcement.

*(Fire Prevention and Building Safety Commission; 675 IAC 14-4.3-66; filed Jun 13, 2005, 3:00 p.m.: 28 IR 3272, eff 90 days after filing with the Secretary of State)*

**675 IAC 14-4.3-67 Section R403.3.4; termite damage**

Authority: IC 22-13-2-2; IC 22-13-2-13

Affected: IC 22-12; IC 22-13; IC 22-14; IC 22-15; IC 36-7

Sec. 67. Delete SECTION R403.3.4. *(Fire Prevention and Building Safety Commission; 675 IAC 14-4.3-67; filed Jun 13, 2005, 3:00 p.m.: 28 IR 3272, eff 90 days after filing with the Secretary of State)*

**675 IAC 14-4.3-68 Section R404.1; concrete and masonry foundation walls**

Authority: IC 22-13-2-2; IC 22-13-2-13

Affected: IC 22-12; IC 22-13; IC 22-14; IC 22-15; IC 36-7

Sec. 68. Delete the last sentence of SECTION R404.1. *(Fire Prevention and Building Safety Commission; 675 IAC 14-4.3-68; filed Jun 13, 2005, 3:00 p.m.: 28 IR 3272, eff 90 days after filing with the Secretary of State)*

**675 IAC 14-4.3-69 Section R404.1.1; masonry foundation walls**

Authority: IC 22-13-2-2; IC 22-13-2-13

Affected: IC 22-12; IC 22-13; IC 22-14; IC 22-15; IC 36-7

Sec. 69. Delete SECTION R404.1.1 and substitute to read as follows: Concrete masonry and clay foundation walls shall be constructed as set forth in TABLES R404.1.1(1), R404.1.1(2), R404.1.1(3), and R404.1.1(4) and shall comply with the provisions of this section and the applicable provisions of SECTIONS R606.1 through R606.10, R607, R608, R609, and R610. Rubble masonry foundation walls shall be constructed in accordance with SECTIONS R404.1.8 and R606.2.2.

EXCEPTION: In Seismic Design Category C<sub>1</sub>, TABLE R404.1.1(1) may be used only when the unbalanced fill is 4 feet (1,219

mm) or less. Rubble stone masonry walls shall not be used in Seismic Design Category C<sub>1</sub>.  
(*Fire Prevention and Building Safety Commission; 675 IAC 14-4.3-69; filed Jun 13, 2005, 3:00 p.m.: 28 IR 3272, eff 90 days after filing with the Secretary of State*)

**675 IAC 14-4.3-70 Section R404.1.2; concrete foundation walls**

Authority: IC 22-13-2-2; IC 22-13-2-13

Affected: IC 22-12; IC 22-13; IC 22-14; IC 22-15; IC 36-7

Sec. 70. Delete SECTION R404.1.2 and substitute to read as follows: Concrete foundation walls shall be constructed as set forth in TABLES R404.1.1(1), R404.1.1(2), R404.1.1(3), and R404.1.1(4) and shall also comply with the provisions of this section and the applicable provisions of SECTION R402.2. In Seismic Design Category C<sub>1</sub>, TABLE R404.1.1(1) may be used only when the height of the unbalanced fill is 4 feet (1,219 mm) or less. (*Fire Prevention and Building Safety Commission; 675 IAC 14-4.3-70; filed Jun 13, 2005, 3:00 p.m.: 28 IR 3273, eff 90 days after filing with the Secretary of State*)

**675 IAC 14-4.3-71 Section R404.1.5; foundation wall thickness based on walls supported**

Authority: IC 22-13-2-2; IC 22-13-2-13

Affected: IC 22-12; IC 22-13; IC 22-14; IC 22-15; IC 36-7

Sec. 71. Delete the text of SECTION R404.1.5 and substitute to read: The thickness of concrete and masonry walls shall not be less than the thickness of the wall supported.

EXCEPTION: A foundation wall of at least 8 inches (203 mm) thickness shall be permitted:

1. Under brick veneered frame walls.
2. Under 10 inch (254 mm) wide cavity walls where the total height of the walls supported, including gables, is not more than 20 feet (6,096 mm) provided the requirements of SECTIONS R404.1.1 and R404.1.2 are met.

(*Fire Prevention and Building Safety Commission; 675 IAC 14-4.3-71; filed Jun 13, 2005, 3:00 p.m.: 28 IR 3273, eff 90 days after filing with the Secretary of State*)

**675 IAC 14-4.3-72 Section R404.1.5.1; pier and curtain wall foundations**

Authority: IC 22-13-2-2; IC 22-13-2-13

Affected: IC 22-12; IC 22-13; IC 22-14; IC 22-15; IC 36-7

Sec. 72. Change, in Item 5 of SECTION R404.1.5.1, “accepted” to “approved”. (*Fire Prevention and Building Safety Commission; 675 IAC 14-4.3-72; filed Jun 13, 2005, 3:00 p.m.: 28 IR 3273, eff 90 days after filing with the Secretary of State*)

**675 IAC 14-4.3-73 Section R404.1.6; height above finished grade**

Authority: IC 22-13-2-2; IC 22-13-2-13

Affected: IC 22-12; IC 22-13; IC 22-14; IC 22-15; IC 36-7

Sec. 73. Delete the text of SECTION R404.1.6 and substitute to read as follows: Concrete and masonry foundation walls shall extend above the finished grade adjacent to the foundation at all points a minimum of 6 inches (152 mm). (*Fire Prevention and Building Safety Commission; 675 IAC 14-4.3-73; filed Jun 13, 2005, 3:00 p.m.: 28 IR 3273, eff 90 days after filing with the Secretary of State*)

**675 IAC 14-4.3-74 Section R404.2.1; identification**

Authority: IC 22-13-2-2; IC 22-13-2-13

Affected: IC 22-12; IC 22-13; IC 22-14; IC 22-15; IC 36-7

Sec. 74. Delete the second and third sentences of SECTION R404.2.1. (*Fire Prevention and Building Safety Commission; 675 IAC 14-4.3-74; filed Jun 13, 2005, 3:00 p.m.: 28 IR 3273, eff 90 days after filing with the Secretary of State*)

**675 IAC 14-4.3-75 Section R404.4; insulating concrete form foundation walls**

Authority: IC 22-13-2-2; IC 22-13-2-13

Affected: IC 22-12; IC 22-13; IC 22-14; IC 22-15; IC 36-7

Sec. 75. Delete the last sentence of SECTION R404.4. *(Fire Prevention and Building Safety Commission; 675 IAC 14-4.3-75; filed Jun 13, 2005, 3:00 p.m.: 28 IR 3273, eff 90 days after filing with the Secretary of State)*

**675 IAC 14-4.3-76 Section R404.4.7.2; termite hazards**

Authority: IC 22-13-2-2; IC 22-13-2-13

Affected: IC 22-12; IC 22-13; IC 22-14; IC 22-15; IC 36-7

Sec. 76. Delete SECTION R404.4.7.2. *(Fire Prevention and Building Safety Commission; 675 IAC 14-4.3-76; filed Jun 13, 2005, 3:00 p.m.: 28 IR 3273, eff 90 days after filing with the Secretary of State)*

**675 IAC 14-4.3-77 Section R405.2.3; drainage system**

Authority: IC 22-13-2-2; IC 22-13-2-13

Affected: IC 22-12; IC 22-13; IC 22-14; IC 22-15; IC 36-7

Sec. 77. Change SECTION R405.2.3 to read as follows: In other than Group I soils, a sump pit shall be provided to drain the porous layer and footings. The sump pit shall be a minimum of 18 inches (457 mm) in diameter or equivalent and a minimum of 24 inches (610 mm) below the bottom of the basement floor. Where a porous layer of gravel, crushed stone, or coarse sand is used between the soil and the concrete floor slab, openings shall be made in the sump pit to allow drainage of that layer. The sump pit shall be capable of positive gravity or mechanical drainage to remove any accumulated water.

EXCEPTION: When a gravity drain system is used a sump pit is not required.

*(Fire Prevention and Building Safety Commission; 675 IAC 14-4.3-77; filed Jun 13, 2005, 3:00 p.m.: 28 IR 3273, eff 90 days after filing with the Secretary of State)*

**675 IAC 14-4.3-78 Section R407.3; structural requirement**

Authority: IC 22-13-2-2; IC 22-13-2-13

Affected: IC 22-12; IC 22-13; IC 22-14; IC 22-15; IC 36-7

Sec. 78. In the first sentence of SECTION R407.3, add “top and” after “the” and before “bottom”. *(Fire Prevention and Building Safety Commission; 675 IAC 14-4.3-78; filed Jun 13, 2005, 3:00 p.m.: 28 IR 3274, eff 90 days after filing with the Secretary of State)*

**675 IAC 14-4.3-79 Section R408.2; openings for underfloor ventilation**

Authority: IC 22-13-2-2; IC 22-13-2-13

Affected: IC 22-12; IC 22-13; IC 22-14; IC 22-15; IC 36-7

Sec. 79. Make the following changes to SECTION R408.2: (a) Change Exception 1 to read as follows: Ventilation openings to the outdoors are not required if ventilation openings to the interior are provided.

(b) Amend Exception 5 as follows: delete “Section N1102.1.7” and substitute “Chapter 11 of this code”. *(Fire Prevention and Building Safety Commission; 675 IAC 14-4.3-79; filed Jun 13, 2005, 3:00 p.m.: 28 IR 3274, eff 90 days after filing with the Secretary of State)*

**675 IAC 14-4.3-80 Section R408.3; access**

Authority: IC 22-13-2-2; IC 22-13-2-13

Affected: IC 22-12; IC 22-13; IC 22-14; IC 22-15; IC 36-7

Sec. 80. Change SECTION R408.3 to read as follows: An access opening 24 inches by 18 inches (610 mm by 457 mm) shall be provided to the underfloor space. When the underfloor space access opening is through a wall, the opening shall be a minimum

of 24 inches (609 mm) wide by 16 inches (406 mm) high with an areaway provided for access to the underfloor opening. The areaway shall be not less than 24 inches (609 mm) long parallel to the wall at the access opening by 16 inches (406 mm) wide perpendicular to the wall at the center of the access opening. The bottom of the areaway shall be below the threshold of the access opening. The underfloor access opening shall not be under a door. *(Fire Prevention and Building Safety Commission; 675 IAC 14-4.3-80; filed Jun 13, 2005, 3:00 p.m.: 28 IR 3274, eff 90 days after filing with the Secretary of State)*

**675 IAC 14-4.3-81 Section R408.6; flood resistance**

Authority: IC 22-13-2-2; IC 22-13-2-13  
 Affected: IC 22-12; IC 22-13; IC 22-14; IC 22-15; IC 36-7

Sec. 81. Delete the title and text of SECTION R408.6 and substitute to read as follows: Underfloor drainage. In other than Group I soils, underfloor spaces shall be drained to prevent water accumulation by one of the following methods:

1. The underfloor space shall be graded at a slope of not less than 1 inch (25 mm) for each 10 feet (3,048 mm) to a gravity discharge or a sump pit having a minimum size of 18 inches (457 mm) in diameter by 24 inches (610 mm) deep installed below the lowest point of the slope so that, in the event of excess water accumulation, a sump pump can be readily installed.
2. The underfloor space shall be graded at a slope of not less than ½ inch (13 mm) for each 10 feet (3,048 mm) to a gravity discharge or a sump pit having a minimum size of 18 inches (457 mm) in diameter by 24 inches (610 mm) deep installed below the lowest point of the slope and not less than 3 inches (76 mm) of granular material shall be placed between the ground surface and the vapor retarder so that, in the event of excess water accumulation, a sump pump can be readily installed.

*(Fire Prevention and Building Safety Commission; 675 IAC 14-4.3-81; filed Jun 13, 2005, 3:00 p.m.: 28 IR 3274, eff 90 days after filing with the Secretary of State)*

**675 IAC 14-4.3-82 Section R502.1; identification**

Authority: IC 22-13-2-2; IC 22-13-2-13  
 Affected: IC 22-12; IC 22-13; IC 22-14; IC 22-15; IC 36-7

Sec. 82. Delete the last sentence of SECTION R502.1. *(Fire Prevention and Building Safety Commission; 675 IAC 14-4.3-82; filed Jun 13, 2005, 3:00 p.m.: 28 IR 3274, eff 90 days after filing with the Secretary of State)*

**675 IAC 14-4.3-83 Section R502.2.1; decks**

Authority: IC 22-13-2-2; IC 22-13-2-13  
 Affected: IC 22-12; IC 22-13; IC 22-14; IC 22-15; IC 36-7

Sec. 83. Change SECTION R502.2.1 as follows: (a) Change the second sentence to read “Such attachment shall be made with bolts or lag screws, according to Table R502.2.1.”

(b) In the third sentence, delete “verified during construction” and substitute “achieved”. *(Fire Prevention and Building Safety Commission; 675 IAC 14-4.3-83; filed Jun 13, 2005, 3:00 p.m.: 28 IR 3274, eff 90 days after filing with the Secretary of State)*

**675 IAC 14-4.3-84 Table R502.2.1; MAXIMUM SPACING OF FASTENERS FOR LEDGERS SUPPORTING DECKS**

Authority: IC 22-13-2-2; IC 22-13-2-13  
 Affected: IC 22-12; IC 22-13; IC 22-14; IC 22-15; IC 36-7

Sec. 84. Add TABLE R502.2.1 as follows:

TABLE R502.2.1  
 SPACING OF FASTENERS FOR LEDGERS  
 SUPPORTING DECKS  
 MAXIMUM FASTENER SPACING IN INCHES<sup>a, c, f, g</sup>

JOIST SPAN	6'	8'	10'	12'	14'	16'	18'
Lag Screws <sup>b, d, e</sup>	30	23	18	15	13	11	10

ONE AND TWO FAMILY DWELLING CODE

Bolts <sup>b, e</sup>	36	36	34	29	24	21	19
-----------------------	----	----	----	----	----	----	----

<sup>a</sup>Bolts or lag screws shall be a minimum of ½ inch in diameter.

<sup>b</sup>Assumes connection directly to 1½ inch thick solid wood or 1⅞ inch thick composite wood band joist or through maximum ½ inch thick wood sheathing to band joist.

<sup>c</sup>Flash ledger in accordance with SECTION R703.8(5).

<sup>d</sup>Lag screws shall fully penetrate the band joist and be staggered to prevent splitting.

<sup>e</sup>Washers shall be installed under lag screw heads, bolt heads, and nuts. Carriage bolts shall have a washer under the nut.

<sup>f</sup>Ledgers shall be anchored to the band joist with a minimum of two fasteners per ledger section with one fastener located not more than 12 inches (30.5 cm) or less than seven bolt diameters from the end of each ledger section.

<sup>g</sup>With a minimum 1⅞ inch (28.6 mm) composite wood band joist, bolts shall be used; lag screws shall not be used.

*(Fire Prevention and Building Safety Commission; 675 IAC 14-4.3-84; filed Jun 13, 2005, 3:00 p.m.: 28 IR 3274, eff 90 days after filing with the Secretary of State)*

**675 IAC 14-4.3-85      Figure R502.2; floor construction**

Authority: IC 22-13-2-2; IC 22-13-2-13

Affected: IC 22-12; IC 22-13; IC 22-14; IC 22-15; IC 36-7

Sec. 85. Add a note to the joist between the fireplace and the center girder to read as follows: TAIL JOIST - SEE SECTION R502.10. *(Fire Prevention and Building Safety Commission; 675 IAC 14-4.3-85; filed Jun 13, 2005, 3:00 p.m.: 28 IR 3275, eff 90 days after filing with the Secretary of State)*

**675 IAC 14-4.3-86      Table R502.3.3(2); cantilever spans for floor joists supporting exterior balcony**

Authority: IC 22-13-2-2; IC 22-13-2-13

Affected: IC 22-12; IC 22-13; IC 22-14; IC 22-15; IC 36-7

Sec. 86. (a) Add a reference to footnotes “g” and “h” in the title of TABLE R502.3.3(2).

(b) Add footnote “g” to read as follows: <sup>g</sup>In addition to snow loads shown, the table includes 60 psf of live load.

(c) Add footnote “h” to read as follows: <sup>h</sup>Use of the table shall be permitted for the construction of interior balconies not supporting roof loads. *(Fire Prevention and Building Safety Commission; 675 IAC 14-4.3-86; filed Jun 13, 2005, 3:00 p.m.: 28 IR 3275, eff 90 days after filing with the Secretary of State)*

**675 IAC 14-4.3-87      Section R502.8.1; sawn lumber**

Authority: IC 22-13-2-2; IC 22-13-2-13

Affected: IC 22-12; IC 22-13; IC 22-14; IC 22-15; IC 36-7

Sec. 87. Add an exception to SECTION R502.8.1 to read as follows: EXCEPTION: In 2 × 8 and larger solid lumber joists, holes up to 50 percent of the actual joist depth may be drilled at the center of the joist depth in the second and fifth sixths of the joist span. When the joist spans 90 percent or less of its maximum allowed span per TABLE R502.3.1(1) or R502.3.1(2), such holes may also be located in the center third of the joist span. Such hole shall be no closer than 6 inches (152 mm) from any other hole. Except for end notches, no notches may be in the same half of the span as a hole allowed by this exception. *(Fire Prevention and Building Safety Commission; 675 IAC 14-4.3-87; filed Jun 13, 2005, 3:00 p.m.: 28 IR 3275, eff 90 days after filing with the Secretary of State)*

**675 IAC 14-4.3-88      Figure R502.8; cutting, notching, and drilling**

Authority: IC 22-13-2-2; IC 22-13-2-13

Affected: IC 22-12; IC 22-13; IC 22-14; IC 22-15; IC 36-7

Sec. 88. Delete FIGURE R502.8 and substitute as follows: FIGURE R502.8:



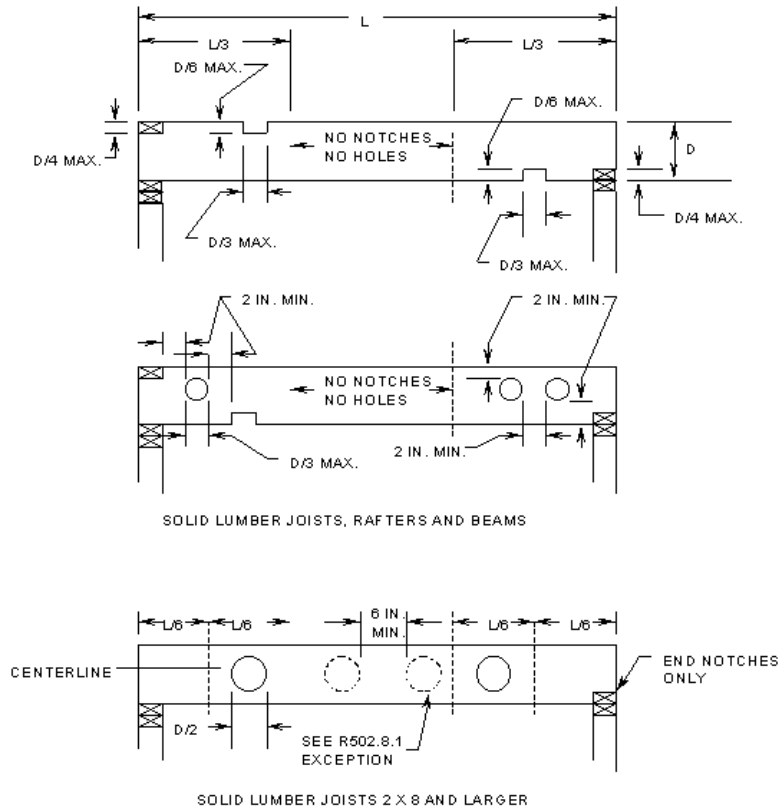

FIGURE R502.8  
CUTTING, NOTCHING AND DRILLING

*(Fire Prevention and Building Safety Commission; 675 IAC 14-4.3-88; filed Jun 13, 2005, 3:00 p.m.: 28 IR 3275, eff 90 days after filing with the Secretary of State)*

**675 IAC 14-4.3-89 Section R502.11.1; design**

Authority: IC 22-13-2-2; IC 22-13-2-13  
 Affected: IC 22-12; IC 22-13; IC 22-14; IC 22-15; IC 36-7

Sec. 89. Delete the last sentence of SECTION R502.11.1. *(Fire Prevention and Building Safety Commission; 675 IAC 14-4.3-89; filed Jun 13, 2005, 3:00 p.m.: 28 IR 3276, eff 90 days after filing with the Secretary of State)*

**675 IAC 14-4.3-90 Section R502.11.3; alterations to trusses**

Authority: IC 22-13-2-2; IC 22-13-2-13  
 Affected: IC 22-12; IC 22-13; IC 22-14; IC 22-15; IC 25-4; IC 25-31; IC 36-7

Sec. 90. Change the first sentence of SECTION R502.11.3 to read as follows: Truss members and components shall not be cut, notched, spliced, or otherwise altered in any way without the acceptance of the change by an architect registered under IC 25-4 or a professional engineer registered under IC 25-31. *(Fire Prevention and Building Safety Commission; 675 IAC 14-4.3-90; filed Jun 13, 2005, 3:00 p.m.: 28 IR 3276, eff 90 days after filing with the Secretary of State)*

**675 IAC 14-4.3-91 Section R502.11.4; truss design drawings**

Authority: IC 22-13-2-2; IC 22-13-2-13

Affected: IC 22-12; IC 22-13; IC 22-14; IC 22-15; IC 36-7

Sec. 91. Delete SECTION R502.11.4 and substitute to read as follows: Truss design drawings shall be provided to the building official as required by the General Administrative Rules (675 IAC 12) for Class 1 structures or by local ordinance for Class 2 structures. *(Fire Prevention and Building Safety Commission; 675 IAC 14-4.3-91; filed Jun 13, 2005, 3:00 p.m.: 28 IR 3276, eff 90 days after filing with the Secretary of State)*

**675 IAC 14-4.3-92 Section R602.1; identification**

Authority: IC 22-13-2-2; IC 22-13-2-13

Affected: IC 22-12; IC 22-13; IC 22-14; IC 22-15; IC 36-7

Sec. 92. Delete the last sentence of SECTION R602.1. *(Fire Prevention and Building Safety Commission; 675 IAC 14-4.3-92; filed Jun 13, 2005, 3:00 p.m.: 28 IR 3276, eff 90 days after filing with the Secretary of State)*

**675 IAC 14-4.3-93 Section R602.3; design and construction**

Authority: IC 22-13-2-2; IC 22-13-2-13

Affected: IC 22-12; IC 22-13; IC 22-14; IC 22-15; IC 36-7

Sec. 93. In the third sentence of SECTION R602.3, delete “foam plastic sheathing” and substitute “nonstructural sheathing”. *(Fire Prevention and Building Safety Commission; 675 IAC 14-4.3-93; filed Jun 13, 2005, 3:00 p.m.: 28 IR 3276, eff 90 days after filing with the Secretary of State)*

**675 IAC 14-4.3-94 Figure R602.3(1); typical wall, floor, and roof framing**

Authority: IC 22-13-2-2; IC 22-13-2-13

Affected: IC 22-12; IC 22-13; IC 22-14; IC 22-15; IC 36-7

Sec. 94. Change the note in FIGURE R602.3(1) stating “FOR BLOCKING AND BRIDGING - SEE SECTION R502.5” to read “FOR BLOCKING AND BRIDGING-SEE SECTION R502.7”. *(Fire Prevention and Building Safety Commission; 675 IAC 14-4.3-94; filed Jun 13, 2005, 3:00 p.m.: 28 IR 3276, eff 90 days after filing with the Secretary of State)*

**675 IAC 14-4.3-95 Figure R602.6(2); notching and bored hole limitations for interior nonbearing walls**

Authority: IC 22-13-2-2; IC 22-13-2-13

Affected: IC 22-12; IC 22-13; IC 22-14; IC 22-15; IC 36-7

Sec. 95. Delete FIGURE R602.6(2) and insert FIGURE R602.6(2) to read as follows:

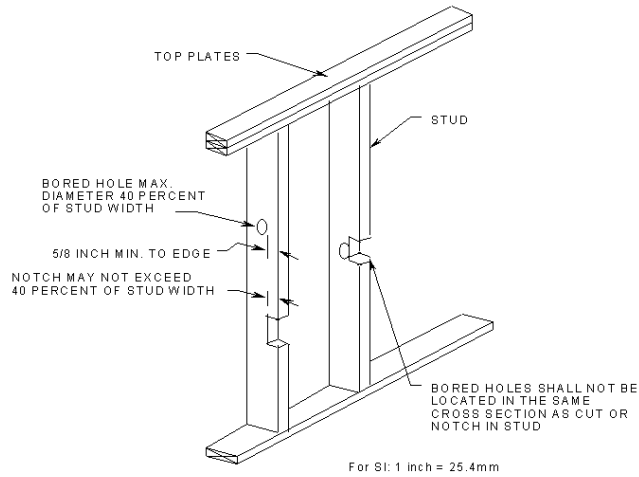

FIGURE R602.6(2)  
NOTCHING AND BORED HOLE LIMITATIONS FOR INTERIOR NONBEARING WALLS

*(Fire Prevention and Building Safety Commission; 675 IAC 14-4.3-95; filed Jun 13, 2005, 3:00 p.m.: 28 IR 3276, eff 90 days after filing with the Secretary of State)*

**675 IAC 14-4.3-96 Section R602.7; headers**

Authority: IC 22-13-2-2; IC 22-13-2-13

Affected: IC 22-12; IC 22-13; IC 22-14; IC 22-15; IC 36-7

Sec. 96. Amend SECTION R602.7, Headers, by adding a section to read as follows: SECTION R602.7.3, Location. Headers less than 2 inches (51 mm) in width that span more than 8 feet (2,438 mm) or headers less than 4 inches (102 mm) in width that span more than 16 feet (4,877 mm) shall be located at the top of the wall immediately below the top plate.

EXCEPTION: When a minimum of 3/8 inch (10 mm) structural wood sheathing is applied from the bottom of the header to the top of the wall and all joints on structural members are fastened in accordance with TABLE R602.3(1) or TABLE R602.3(2).

*(Fire Prevention and Building Safety Commission; 675 IAC 14-4.3-96; filed Jun 13, 2005, 3:00 p.m.: 28 IR 3276, eff 90 days after filing with the Secretary of State)*

**675 IAC 14-4.3-97 Section R602.10.1; braced wall lines**

Authority: IC 22-13-2-2; IC 22-13-2-13

Affected: IC 22-12; IC 22-13; IC 22-14; IC 22-15; IC 36-7

Sec. 97. Add a new paragraph after the first paragraph to SECTION R602.10.1 to read as follows: In an interior braced wall line out-of-plane offsets of up to 12 feet shall be permitted provided that the total out-to-out offset dimension in the braced wall line is not more than 12 feet. When the 4 foot offset or 8 foot out-to-out is exceeded in the braced wall line, the amount of bracing shall be increased by 50 percent. This increase shall be in addition to any other required increase. *(Fire Prevention and Building Safety Commission; 675 IAC 14-4.3-97; filed Jun 13, 2005, 3:00 p.m.: 28 IR 3277, eff 90 days after filing with the Secretary of State)*

**675 IAC 14-4.3-98 Section R602.10.1.1; spacing**

Authority: IC 22-13-2-2; IC 22-13-2-13

Affected: IC 22-12; IC 22-13; IC 22-14; IC 22-15; IC 36-7

Sec. 98. Change 2 in the exception to SECTION R602.10.1.1 to read as follows: The length-to-width ratio for the floor or roof diaphragm does not exceed 3:1. *(Fire Prevention and Building Safety Commission; 675 IAC 14-4.3-98; filed Jun 13, 2005, 3:00 p.m.: 28 IR 3278, eff 90 days after filing with the Secretary of State)*

28 IR 3277, eff 90 days after filing with the Secretary of State)

**675 IAC 14-4.3-99 Table R602.10.1; wall bracing**

Authority: IC 22-13-2-2; IC 22-13-2-13

Affected: IC 22-12; IC 22-13; IC 22-14; IC 22-15; IC 36-7

Sec. 99. Change footnote (a) in TABLE R602.10.1 by deleting "Section 1615 of the International Building Code" and substituting "the Indiana Building Code (675 IAC 13)". (*Fire Prevention and Building Safety Commission; 675 IAC 14-4.3-99; filed Jun 13, 2005, 3:00 p.m.: 28 IR 3277, eff 90 days after filing with the Secretary of State*)

**675 IAC 14-4.3-100 Section R602.10.5; continuous structural panel sheathing**

Authority: IC 22-13-2-2; IC 22-13-2-13

Affected: IC 22-12; IC 22-13; IC 22-14; IC 22-15; IC 36-7

Sec. 100. Make the following changes to SECTION 602.10.5: (a) In the first sentence, delete "all walls and interior braced wall lines," and insert "an exterior wall line," and, after "braced wall panel lengths", insert "for such a wall line".

(b) In the second sentence, after "R602.10.5", insert "for such a wall line".

(c) Add an exception to read as follows: EXCEPTION: Vertical wall segments in the first of one or first of two story buildings next to garage openings shall be permitted to have 6:1 height-to-width ratio (with height being measured from top of header to sill plate) when constructed in accordance with the following provisions. Each panel shall have a length of not less than 16 inches (406 mm) and a height of not more than 10 feet (3,048 mm). Each panel shall be sheathed on one face with a single layer of 3/8 inch minimum thickness (9.5 mm) wood structural panel sheathing nailed with 8d common or galvanized box nails in accordance with Figure R602.10.5(2). The wood structural panel sheathing shall extend up over the solid swan or glued-laminated header and shall be nailed in accordance with Figure R602.10.5(2). The header shall extend between the inside faces of the first full-length outer studs of each panel. The clear span of the header between the inner studs of each panel shall be not less than 6 feet (1,829 mm) and not more than 18 feet (5,486 mm) in length. A strap with an uplift capacity of not less than 1,000 pounds (454 kg) shall fasten the header to the side of the inner studs opposite the sheathing. Two anchor bolts shall be installed in accordance with Section 403.1.6, and plate washers shall be a minimum of 2 inches by 2 inches by 3/16 inch (51 mm by 51 mm by 4.8 mm) thick and shall be used on each bolt. This exception is only permitted in Seismic Design Categories A-C.

(d) Add FIGURE R602.10.5(2) to read as follows:

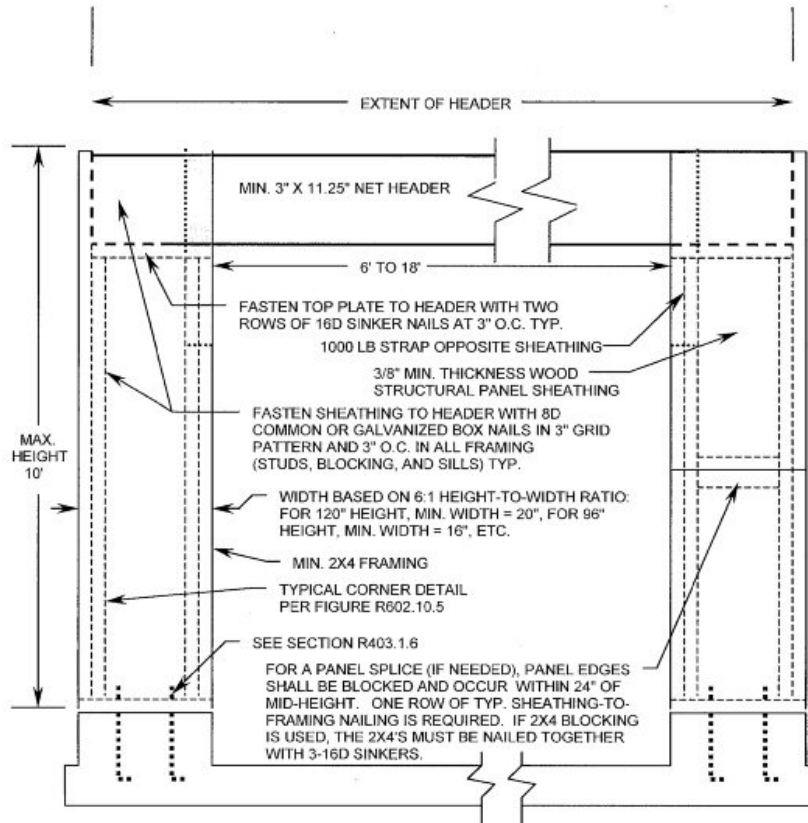

FIGURE R602.10.5(2)  
GARAGE DOOR BRACED WALL PANEL FOR USE  
WITH CONTINUOUSLY SHEATHED WALLS

*(Fire Prevention and Building Safety Commission; 675 IAC 14-4.3-100; filed Jun 13, 2005, 3:00 p.m.: 28 IR 3277, eff 90 days after filing with the Secretary of State; filed Oct 18, 2006, 2:39 p.m.: 20061115-IR-675050348FRA)*

**675 IAC 14-4.3-101 Table R602.10.11; adjustment of bracing amounts for interior braced wall lines according to braced wall line spacing**

Authority: IC 22-13-2-2; IC 22-13-2-13  
Affected: IC 22-12; IC 22-13; IC 22-14; IC 22-15; IC 36-7

Sec. 101. Change TABLE R602.10.11 by deleting “Table R602.10.3” in the second column and substituting “Table R602.10.1”. *(Fire Prevention and Building Safety Commission; 675 IAC 14-4.3-101; filed Jun 13, 2005, 3:00 p.m.: 28 IR 3278, eff 90 days after filing with the Secretary of State)*

**675 IAC 14-4.3-102 Section R604.1; identification and grade**

Authority: IC 22-13-2-2; IC 22-13-2-13  
Affected: IC 22-12; IC 22-13; IC 22-14; IC 22-15; IC 36-7

Sec. 102. In the last sentence of SECTION R604.1, delete “or certificate of inspection issued by an approved agency”. *(Fire Prevention and Building Safety Commission; 675 IAC 14-4.3-102; filed Jun 13, 2005, 3:00 p.m.: 28 IR 3278, eff 90 days after filing with the Secretary of State)*

**675 IAC 14-4.3-103 Section R604.3; installation**

Authority: IC 22-13-2-2; IC 22-13-2-13

Affected: IC 22-12; IC 22-13; IC 22-14; IC 22-15; IC 36-7

Sec. 103. Delete the last sentence of SECTION R604.3 without substitution. *(Fire Prevention and Building Safety Commission; 675 IAC 14-4.3-103; filed Jun 13, 2005, 3:00 p.m.: 28 IR 3278, eff 90 days after filing with the Secretary of State)*

**675 IAC 14-4.3-104 Section R605.1; identification and grade**

Authority: IC 22-13-2-2; IC 22-13-2-13

Affected: IC 22-12; IC 22-13; IC 22-14; IC 22-15; IC 36-7

Sec. 104. Delete, from the first sentence of SECTION R605.1, “or certificate of inspection issued by an approved agency”. *(Fire Prevention and Building Safety Commission; 675 IAC 14-4.3-104; filed Jun 13, 2005, 3:00 p.m.: 28 IR 3278, eff 90 days after filing with the Secretary of State)*

**675 IAC 14-4.3-105 Section R606.1.1; professional registration not required**

Authority: IC 22-13-2-2; IC 22-13-2-13

Affected: IC 22-12; IC 22-13; IC 22-14; IC 22-15; IC 36-7

Sec. 105. Delete SECTION R606.1.1. *(Fire Prevention and Building Safety Commission; 675 IAC 14-4.3-105; filed Jun 13, 2005, 3:00 p.m.: 28 IR 3278, eff 90 days after filing with the Secretary of State)*

**675 IAC 14-4.3-106 Section R606.2; thickness of masonry**

Authority: IC 22-13-2-2; IC 22-13-2-13

Affected: IC 22-12; IC 22-13; IC 22-14; IC 22-15; IC 36-7

Sec. 106. Add a second sentence to SECTION R606.2 to read as follows: The nominal thickness of foundation walls shall conform to the requirements of SECTION R404. *(Fire Prevention and Building Safety Commission; 675 IAC 14-4.3-106; filed Jun 13, 2005, 3:00 p.m.: 28 IR 3278, eff 90 days after filing with the Secretary of State)*

**675 IAC 14-4.3-107 Section R606.2.1; minimum thickness**

Authority: IC 22-13-2-2; IC 22-13-2-13

Affected: IC 22-12; IC 22-13; IC 22-14; IC 22-15

Sec. 107. Delete the last sentence of SECTION R606.2.1 and substitute to read as follows: The minimum thickness of masonry foundation walls shall comply with SECTION R404. Masonry walls, except masonry foundation walls, shall be laterally supported in either the horizontal or vertical direction at intervals as required by SECTION R606.8. *(Fire Prevention and Building Safety Commission; 675 IAC 14-4.3-107; filed Jun 13, 2005, 3:00 p.m.: 28 IR 3278, eff 90 days after filing with the Secretary of State)*

**675 IAC 14-4.3-108 Section R606.10; anchorage**

Authority: IC 22-13-2-2; IC 22-13-2-13

Affected: IC 22-12; IC 22-13; IC 22-14; IC 22-15

Sec. 108. Add an exception to SECTION R606.10 to read as follows: EXCEPTION: Masonry foundation walls in Seismic Design Category C<sub>1</sub> are exempt from the requirements of Figure R606.10(3) and shall comply with the requirements of SECTION R404. *(Fire Prevention and Building Safety Commission; 675 IAC 14-4.3-108; filed Jun 13, 2005, 3:00 p.m.: 28 IR 3278, eff 90 days after filing with the Secretary of State)*

**675 IAC 14-4.3-109 Section R606.11; seismic requirements**

Authority: IC 22-13-2-2; IC 22-13-2-13

Affected: IC 22-12; IC 22-13; IC 22-14; IC 22-15; IC 36-7

Sec. 109. Make the following changes to SECTION R606.11: (a) Add, at the end of the first sentence, “C<sub>1</sub>” between “C” and “D<sub>1</sub>”.

(b) Add an exception to read as follows: EXCEPTION: Masonry foundation walls in Seismic Design Category C and C<sub>1</sub> are exempt from the requirements of Figure R606.10(3) and shall comply with SECTION R404. *(Fire Prevention and Building Safety Commission; 675 IAC 14-4.3-109; filed Jun 13, 2005, 3:00 p.m.: 28 IR 3278, eff 90 days after filing with the Secretary of State)*

**675 IAC 14-4.3-110 Section R606.11.2; Seismic Design Category C**

Authority: IC 22-13-2-2; IC 22-13-2-13

Affected: IC 22-12; IC 22-13; IC 22-14; IC 22-15; IC 36-7

Sec. 110. Make the following changes to SECTION R606.11.2: (a) Change the title and text of SECTION R606.11.2 to read as follows: Seismic Design Category C and C<sub>1</sub>. Structures located in Seismic Design Category C and C<sub>1</sub> shall comply with the requirements of this section.

(b) Add an exception to read as follows: EXCEPTION: Masonry foundation walls in Seismic Design Category C and C<sub>1</sub> are exempt from the requirements of Figure R606.10(3) and shall comply with SECTION R404. *(Fire Prevention and Building Safety Commission; 675 IAC 14-4.3-110; filed Jun 13, 2005, 3:00 p.m.: 28 IR 3278, eff 90 days after filing with the Secretary of State)*

**675 IAC 14-4.3-111 Figure R606.10(2); requirements for reinforced grouted masonry construction in Seismic Design Category C**

Authority: IC 22-13-2-2; IC 22-13-2-13

Affected: IC 22-12; IC 22-13; IC 22-14; IC 22-15; IC 36-7

Sec. 111. Add, to the end of the title to FIGURE R606.10(2), “and C<sub>1</sub>”. *(Fire Prevention and Building Safety Commission; 675 IAC 14-4.3-111; filed Jun 13, 2005, 3:00 p.m.: 28 IR 3279, eff 90 days after filing with the Secretary of State)*

**675 IAC 14-4.3-112 Section R607.1.2; masonry in seismic design categories A, B, C, and C<sub>1</sub>**

Authority: IC 22-13-2-2; IC 22-13-2-13

Affected: IC 22-12; IC 22-13; IC 22-14; IC 22-15; IC 36-7

Sec. 112. Change SECTION R607.1.2 to read as follows: R607.1.2 Masonry in Seismic Design Categories A, B, C, and C<sub>1</sub>. Mortar for masonry serving as the lateral-force-resisting system in Seismic Design Categories A, B, C, and C<sub>1</sub> shall be Type M, S, or N mortar. *(Fire Prevention and Building Safety Commission; 675 IAC 14-4.3-112; filed Jun 13, 2005, 3:00 p.m.: 28 IR 3279, eff 90 days after filing with the Secretary of State)*

**675 IAC 14-4.3-113 Section R609.1.5; cleanouts**

Authority: IC 22-13-2-2; IC 22-13-2-13

Affected: IC 22-12; IC 22-13; IC 22-14; IC 22-15; IC 36-7

Sec. 113. Change SECTION R609.1.5 to read as follows: Cleanouts shall be provided as specified in this section. The cleanouts shall be sealed before grouting. *(Fire Prevention and Building Safety Commission; 675 IAC 14-4.3-113; filed Jun 13, 2005, 3:00 p.m.: 28 IR 3279, eff 90 days after filing with the Secretary of State)*

**675 IAC 14-4.3-114 Section R609.4.1; construction**

Authority: IC 22-13-2-2; IC 22-13-2-13

Affected: IC 22-12; IC 22-13; IC 22-14; IC 22-15; IC 36-7

Sec. 114. Delete, in SECTION R609.4.1, Item 4, the following: “and special inspection during grouting shall be required”. *(Fire Prevention and Building Safety Commission; 675 IAC 14-4.3-114; filed Jun 13, 2005, 3:00 p.m.: 28 IR 3279, eff 90 days after filing with the Secretary of State)*

**675 IAC 14-4.3-115 Section R611.1; general**

Authority: IC 22-13-2-2; IC 22-13-2-13

Affected: IC 22-12; IC 22-13; IC 22-14; IC 22-15; IC 36-7

Sec. 115. Delete the last sentence of SECTION R611.1 and substitute to read as follows: "In Seismic Design Category C<sub>1</sub>, for a townhouse having one or more insulating concrete form exterior walls, the noninsulating concrete form walls and interior bearing walls shall comply with the provisions of SECTION R611". (*Fire Prevention and Building Safety Commission; 675 IAC 14-4.3-115; filed Jun 13, 2005, 3:00 p.m.: 28 IR 3279, eff 90 days after filing with the Secretary of State*)

**675 IAC 14-4.3-116 Table R703.4; weather-resistant siding attachment and minimum thickness**

Authority: IC 22-13-2-2; IC 22-13-2-13

Affected: IC 22-12; IC 22-13; IC 22-14; IC 22-15; IC 36-7

Sec. 116. Change TABLE R703.4 as follows: (a) Change footnote m to read as follows: For masonry veneer, a weather-resistant sheathing paper is not required over water-repellent sheathing materials applied according to manufacturer's instructions and a ¾ inch (19 mm) air space is provided. When the ¾ inch (19 mm) space is filled with mortar, a weather-resistant sheathing paper is required over the sheathing.

(b) In the column titled "Sheathing paper required", add a footnote designation "s" at all three (3) places for Horizontal Aluminum and for Vinyl Siding.

(c) Add a new footnote "s" to read as follows: Unless required by the siding manufacturer's installation instructions. (*Fire Prevention and Building Safety Commission; 675 IAC 14-4.3-116; filed Jun 13, 2005, 3:00 p.m.: 28 IR 3279, eff 90 days after filing with the Secretary of State*)

**675 IAC 14-4.3-117 Section R703.7; stone and masonry veneer, general**

Authority: IC 22-13-2-2; IC 22-13-2-13

Affected: IC 22-12; IC 22-13; IC 22-14; IC 22-15; IC 36-7

Sec. 117. Change Exception 2 in SECTION R703.7 by adding "and C<sub>1</sub>" after "C" and before the ",". (*Fire Prevention and Building Safety Commission; 675 IAC 14-4.3-117; filed Jun 13, 2005, 3:00 p.m.: 28 IR 3279, eff 90 days after filing with the Secretary of State*)

**675 IAC 14-4.3-118 Figure R703.7; masonry veneer wall details**

Authority: IC 22-13-2-2; IC 22-13-2-13

Affected: IC 22-12; IC 22-13; IC 22-14; IC 22-15; IC 36-7

Sec. 118. Change FIGURE R703.7 by changing "1 inch" to "¾ inch" in two (2) places. (*Fire Prevention and Building Safety Commission; 675 IAC 14-4.3-118; filed Jun 13, 2005, 3:00 p.m.: 28 IR 3280, eff 90 days after filing with the Secretary of State*)

**675 IAC 14-4.3-119 Section R703.7.4.2; air space**

Authority: IC 22-13-2-2; IC 22-13-2-13

Affected: IC 22-12; IC 22-13; IC 22-14; IC 22-15; IC 36-7

Sec. 119. Delete the text of SECTION R703.7.4.2 and substitute to read as follows: The masonry veneer shall be separated from the sheathing by an air space of not less than ¾ inch (19 mm) but not more than 4½ inches (114 mm) The weather-resistant sheathing paper as required by SECTION R703.2 is not required over water-repellent sheathing materials installed according to manufacturer's instructions. (*Fire Prevention and Building Safety Commission; 675 IAC 14-4.3-119; filed Jun 13, 2005, 3:00 p.m.: 28 IR 3280, eff 90 days after filing with the Secretary of State*)

**675 IAC 14-4.3-120 Section R703.7.4.3; mortar or grout filled**

Authority: IC 22-13-2-2; IC 22-13-2-13

Affected: IC 22-12; IC 22-13; IC 22-14; IC 22-15; IC 36-7



ONE AND TWO FAMILY DWELLING CODE

Sec. 120. Amend SECTION R703.7.4.3 by deleting “1 inch (25.4 mm)” and inserting “¾ inch (19 mm)”. (Fire Prevention and Building Safety Commission; 675 IAC 14-4.3-120; filed Jun 13, 2005, 3:00 p.m.: 28 IR 3280, eff 90 days after filing with the Secretary of State)

**675 IAC 14-4.3-121 Section R703.7.6; weepholes**

Authority: IC 22-13-2-2; IC 22-13-2-13

Affected: IC 22-12; IC 22-13; IC 22-14; IC 22-15; IC 36-7

Sec. 121. Delete the title and text of SECTION R703.7.6 and substitute as follows: R703.7.6 Drained cavity. The ¾ inch (19 mm) air cavity shall be drained to the exterior of the structure at intervals of not more than 33 inches (838 mm) on center. Each drain shall be not less than 3/16 inch (4.8 mm) in diameter, located immediately above the flashing. For dwellings with crawl spaces, the air cavity may be drained as shown in FIGURE R703.7.6(1). For dwellings with basements, the air cavity may be drained as shown in FIGURE R703.7.6(2).

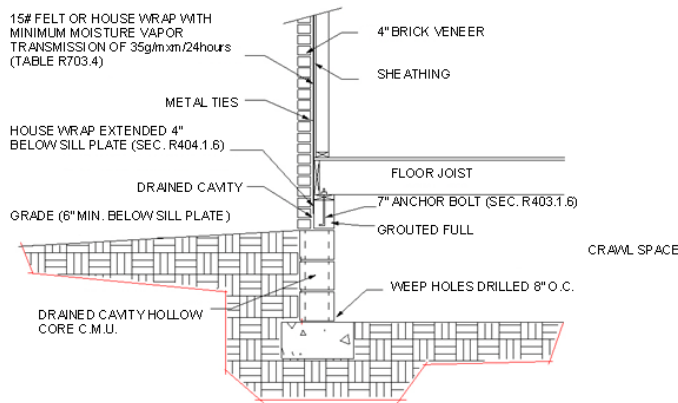

FIGURE R703.7.6(1)

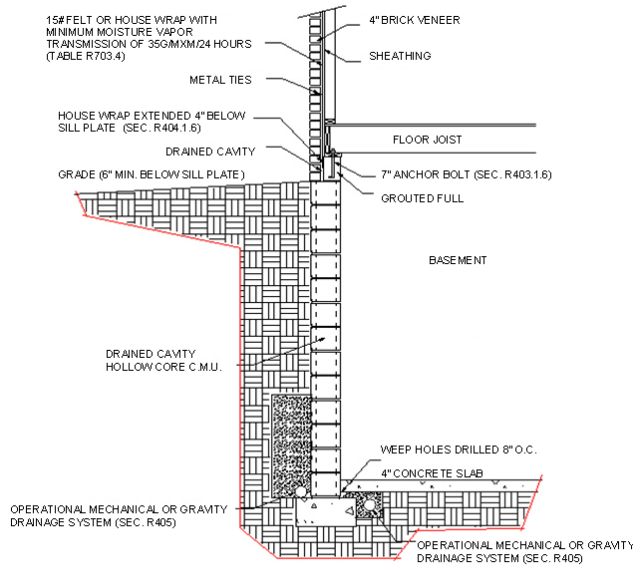

FIGURE R703.7.6(2)

(Fire Prevention and Building Safety Commission; 675 IAC 14-4.3-121; filed Jun 13, 2005, 3:00 p.m.: 28 IR 3280, eff 90 days after filing with the Secretary of State)

**675 IAC 14-4.3-122 Section R703.8; flashing**

Authority: IC 22-13-2-2; IC 22-13-2-13

Affected: IC 22-12; IC 22-13; IC 22-14; IC 22-15; IC 36-7

Sec. 122. In SECTION 703.8, delete Item 1 and substitute to read as follows: 1. Corrosion-resistive flashing shall be provided at the sill, jambs, and top of all windows and door openings, applied shingle fashion in such a manner as to be leakproof. Tops of trim over these openings will also be head flashed in a manner as to direct water over the exterior wall cladding and not behind such trim. This head flashing may be omitted when protected by a soffit, porch, or similar overhang. Windows, indicated by the manufacturer as self-flashing, having a continuous lap of not less than 1 1/8 inches (28 mm) over the sheathing material or building paper around the entire perimeter of the opening, including corners, do not require additional flashing. *(Fire Prevention and Building Safety Commission; 675 IAC 14-4.3-122; filed Jun 13, 2005, 3:00 p.m.: 28 IR 3280, eff 90 days after filing with the Secretary of State)*

**675 IAC 14-4.3-123 Section R802.1; identification and grade**

Authority: IC 22-13-2-2; IC 22-13-2-13

Affected: IC 22-12; IC 22-13; IC 22-14; IC 22-15; IC 36-7

Sec. 123. Delete the last sentence of SECTION R802.1. *(Fire Prevention and Building Safety Commission; 675 IAC 14-4.3-123; filed Jun 13, 2005, 3:00 p.m.: 28 IR 3281, eff 90 days after filing with the Secretary of State)*

**675 IAC 14-4.3-124 Section R802.10.1; truss design drawings**

Authority: IC 22-13-2-2; IC 22-13-2-13

Affected: IC 22-12; IC 22-13; IC 22-14; IC 22-15; IC 36-7

Sec. 124. Delete SECTION R802.10.1 and substitute to read as follows: Truss design drawings shall be provided to the building official as required by the General Administrative Rules (675 IAC 12) for Class 1 structures or by local ordinance for Class 2 structures. *(Fire Prevention and Building Safety Commission; 675 IAC 14-4.3-124; filed Jun 13, 2005, 3:00 p.m.: 28 IR 3281, eff 90 days after filing with the Secretary of State)*

**675 IAC 14-4.3-125 Section R802.10.2; design**

Authority: IC 22-13-2-2; IC 22-13-2-13

Affected: IC 22-12; IC 22-13; IC 22-14; IC 22-15; IC 36-7

Sec. 125. Delete the last sentence of SECTION R802.10.2. *(Fire Prevention and Building Safety Commission; 675 IAC 14-4.3-125; filed Jun 13, 2005, 3:00 p.m.: 28 IR 3281, eff 90 days after filing with the Secretary of State)*

**675 IAC 14-4.3-126 Section R802.10.4; alterations to trusses**

Authority: IC 22-13-2-2; IC 22-13-2-13

Affected: IC 22-12; IC 22-13; IC 22-14; IC 22-15; IC 25-4; IC 25-31; IC 36-7

Sec. 126. Change the first sentence of SECTION R802.10.4 to read as follows: Truss members shall not be cut, notched, drilled, spliced, or otherwise altered in any way without the acceptance of an architect registered under IC 25-4 or a professional engineer registered under IC 25-31, the manufacturer of the truss members, or approved by the building official. *(Fire Prevention and Building Safety Commission; 675 IAC 14-4.3-126; filed Jun 13, 2005, 3:00 p.m.: 28 IR 3281, eff 90 days after filing with the Secretary of State)*

**675 IAC 14-4.3-127 Section R802.10.5; truss to wall connection**

Authority: IC 22-13-2-2; IC 22-13-2-13

Affected: IC 22-12; IC 22-13; IC 22-14; IC 22-15; IC 36-7

Sec. 127. Change SECTION R802.10.5 as follows: (a) Delete “approved connector” and substitute “mechanical fasteners or

connectors”.

(b) Add an exception to read as follows: EXCEPTION: When the uplift shown on the truss drawing is less than 175 pounds the uplift on the drawing may be used. *(Fire Prevention and Building Safety Commission; 675 IAC 14-4.3-127; filed Jun 13, 2005, 3:00 p.m.: 28 IR 3281, eff 90 days after filing with the Secretary of State)*

**675 IAC 14-4.3-128 Section R803.2.1; identification and grade**

Authority: IC 22-13-2-2; IC 22-13-2-13

Affected: IC 22-12; IC 22-13; IC 22-14; IC 22-15; IC 36-7

Sec. 128. Delete, from the first sentence of SECTION R803.2.1, “or certificate of inspection issued by an approved agency”. *(Fire Prevention and Building Safety Commission; 675 IAC 14-4.3-128; filed Jun 13, 2005, 3:00 p.m.: 28 IR 3281, eff 90 days after filing with the Secretary of State)*

**675 IAC 14-4.3-129 Section R806.1; ventilation required**

Authority: IC 22-13-2-2; IC 22-13-2-13

Affected: IC 22-12; IC 22-13; IC 22-14; IC 22-15; IC 36-7

Sec. 129. Add an exception to Section R806.1 to read as follows: EXCEPTION: Mechanical ventilation is permitted provided the following conditions are met:

1. The installation complies with manufacturer’s instructions.
2. A humidistat is included with the installation.
3. An ammeter or equivalent device is installed in a readily visible location.

*(Fire Prevention and Building Safety Commission; 675 IAC 14-4.3-129; filed Jun 13, 2005, 3:00 p.m.: 28 IR 3281, eff 90 days after filing with the Secretary of State)*

**675 IAC 14-4.3-130 Section R808.1; combustible insulation**

Authority: IC 22-13-2-2; IC 22-13-2-13

Affected: IC 22-12; IC 22-13; IC 22-14; IC 22-15; IC 36-7

Sec. 130. In SECTION R808.1, delete “Section N1102.1.11” and substitute “Chapter 11 of this code”. *(Fire Prevention and Building Safety Commission; 675 IAC 14-4.3-130; filed Jun 13, 2005, 3:00 p.m.: 28 IR 3281, eff 90 days after filing with the Secretary of State)*

**675 IAC 14-4.3-131 Section R903.4.1; overflow drains and scuppers**

Authority: IC 22-13-2-2; IC 22-13-2-13

Affected: IC 22-12; IC 22-13; IC 22-14; IC 22-15; IC 36-7

Sec. 131. Delete the last paragraph of SECTION R903.4.1. *(Fire Prevention and Building Safety Commission; 675 IAC 14-4.3-131; filed Jun 13, 2005, 3:00 p.m.: 28 IR 3281, eff 90 days after filing with the Secretary of State)*

**675 IAC 14-4.3-132 Section R904.3; material specifications and physical characteristics**

Authority: IC 22-13-2-2; IC 22-13-2-13

Affected: IC 22-12; IC 22-13; IC 22-14; IC 22-15; IC 36-7

Sec. 132. Delete the last sentence of SECTION R904.3. *(Fire Prevention and Building Safety Commission; 675 IAC 14-4.3-132; filed Jun 13, 2005, 3:00 p.m.: 28 IR 3282, eff 90 days after filing with the Secretary of State)*

**675 IAC 14-4.3-133 Section R905.5.3; underlayment**

Authority: IC 22-13-2-2; IC 22-13-2-13

Affected: IC 22-12; IC 22-13; IC 22-14; IC 22-15; IC 36-7

Sec. 133. In the first sentence of SECTION R905.5.3 delete the phrase “is 25°F (-4°C) or less” and insert “is less than 25°F(-4°C)”. (*Fire Prevention and Building Safety Commission; 675 IAC 14-4.3-133; filed Jun 13, 2005, 3:00 p.m.: 28 IR 3282, eff 90 days after filing with the Secretary of State*)

**675 IAC 14-4.3-134 Section R907.3; recovering versus replacement**

Authority: IC 22-13-2-2; IC 22-13-2-13

Affected: IC 22-12; IC 22-13; IC 22-14; IC 22-15; IC 36-7

Sec. 134. Change, in SECTION R907.3, Item 3, “two” to “three”. (*Fire Prevention and Building Safety Commission; 675 IAC 14-4.3-134; filed Jun 13, 2005, 3:00 p.m.: 28 IR 3282, eff 90 days after filing with the Secretary of State*)

**675 IAC 14-4.3-135 Figure R1001.6; termination**

Authority: IC 22-13-2-2; IC 22-13-2-13

Affected: IC 22-12; IC 22-13; IC 22-14; IC 22-15; IC 36-7

Sec. 135. Add FIGURE R1001.6 as follows:

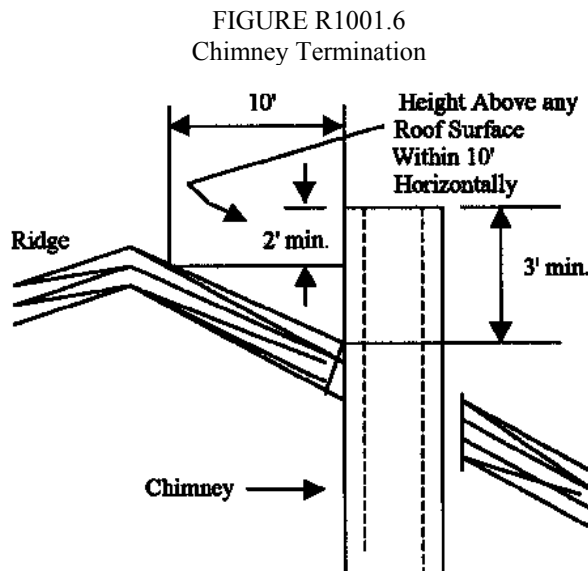

(*Fire Prevention and Building Safety Commission; 675 IAC 14-4.3-135; filed Jun 13, 2005, 3:00 p.m.: 28 IR 3282, eff 90 days after filing with the Secretary of State*)

**675 IAC 14-4.3-136 Section R1003.3; seismic reinforcing**

Authority: IC 22-13-2-2; IC 22-13-2-13

Affected: IC 22-12; IC 22-13; IC 22-14; IC 22-15; IC 36-7

Sec. 136. Change the first sentence of SECTION R1003.3 to read as follows: Masonry or concrete chimneys in Seismic Design Category C<sub>1</sub> shall be reinforced. (*Fire Prevention and Building Safety Commission; 675 IAC 14-4.3-136; filed Jun 13, 2005, 3:00 p.m.: 28 IR 3282, eff 90 days after filing with the Secretary of State*)

**675 IAC 14-4.3-137 Section R1003.4; seismic anchorage**

Authority: IC 22-13-2-2; IC 22-13-2-13

Affected: IC 22-12; IC 22-13; IC 22-14; IC 22-15; IC 36-7

Sec. 137. Change SECTION R1003.4 by deleting D<sub>1</sub> and D<sub>2</sub> and substituting C<sub>1</sub>. (*Fire Prevention and Building Safety*

Commission; 675 IAC 14-4.3-137; filed Jun 13, 2005, 3:00 p.m.: 28 IR 3282, eff 90 days after filing with the Secretary of State)

**675 IAC 14-4.3-138 Section R1005.1; exterior air**

Authority: IC 22-13-2-2; IC 22-13-2-13

Affected: IC 22-12; IC 22-13; IC 22-14; IC 22-15; IC 36-7

Sec. 138. Delete, in SECTION R1005.1, “unless the room is mechanically ventilated and controlled so that the indoor pressure is neutral or positive.” (Fire Prevention and Building Safety Commission; 675 IAC 14-4.3-138; filed Jun 13, 2005, 3:00 p.m.: 28 IR 3282, eff 90 days after filing with the Secretary of State)

**675 IAC 14-4.3-139 Chapter 11; energy efficiency**

Authority: IC 22-13-2-2; IC 22-13-2-13

Affected: IC 22-12; IC 22-13; IC 22-14; IC 22-15; IC 36-7

Sec. 139. Delete the text of Chapter 11 in its entirety and substitute the following: SECTION N1101; GENERAL N1101.1 Scope. This chapter sets forth energy-efficiency requirements for the design and construction of buildings regulated by this code.

EXCEPTION: Provided that they are separated by building envelope assemblies from the remainder of the building, portions of the building that do not enclose conditioned space shall be from the building envelope provisions but shall comply with the provisions for building mechanical and service water systems.

N1101.2 Compliance. Compliance with this chapter shall be demonstrated by meeting the requirements of the applicable sections and tables of SECTIONS N1101, N1102, N1104, and N1105 of this chapter. Compliance with SECTION N1103 or N1106 is an alternative to compliance with SECTION N1102. Where applicable, provisions are based on the climate zone where the building is located as set forth in FIGURE 11-1 below.



FIGURE 11-1

N1101.2.1 Eligible buildings. Compliance for detached one and two family dwellings and for townhouses shall be demonstrated by meeting the requirements of subsection N1101.2.

N1101.3 Materials and equipment. Materials and equipment shall be identified as complying with the provisions of this chapter. Materials and equipment shall be listed and labeled for their intended use and shall be installed in accordance with the manufacturer's installation instructions.

N1101.3.1 Insulation. The thermal resistance (R-value) shall be indicated on all insulation and the insulation installed such that the R-value can be verified during inspection, or evidence of compliance of the installed R-value shall be provided at the job site by the insulation installer.

N1101.3.2 Fenestration. The U-factor of fenestration shall be determined in accordance with NFRC 100 by an accredited, independent laboratory and labeled and certified by the manufacturer. The solar heat gain coefficient (SHGC) of fenestration shall be determined in accordance with NFRC 200 by an accredited, independent laboratory and labeled and certified by the manufacturer.

N1101.3.2.1 Default fenestration performance. When a manufacturer has not determined a fenestration product's U-factor in accordance with NFRC 100, compliance shall be determined by assigning such products a default U-factor from TABLES 11-1 and 11-2. When a manufacturer has not determined a fenestration product's SHGC in accordance with NFRC 200, compliance shall be determined by assigning such products a default SHGC from TABLE 11-3.

TABLE 11-1  
U-FACTOR DEFAULT TABLE FOR WINDOWS, GLAZED DOORS, AND SKYLIGHTS

FRAME MATERIAL AND PRODUCT TYPE <sup>a</sup>	SINGLE GLAZED	DOUBLE GLAZED
<b>Metal without thermal break</b>		
Operable (including sliding and swinging glass doors)	1.27	0.87
Fixed	1.13	0.69
Garden window	2.60	1.81
Curtain wall	1.22	0.79
Skylight	1.98	1.31
Site-assembled sloped/overhead glazing	1.36	0.82
<b>Metal with thermal break</b>		
Operable (including sliding and swinging glass doors)	1.08	0.65
Fixed	1.07	0.63
Curtain wall	1.11	0.68
Skylight	1.89	1.11
Site-assembled sloped/overhead glazing	1.25	0.70
<b>Reinforced vinyl/metal clad wood</b>		
Operable (including sliding and swinging glass doors)	0.90	0.57
Fixed	0.98	0.56
Skylight	1.75	1.05
<b>Wood/vinyl/fiberglass</b>		
Operable (including sliding and swinging glass doors)	0.89	0.55
Fixed	0.98	0.56
Garden window	2.31	1.61
Skylight	1.47	0.84

TABLE 11-2  
U-FACTOR DEFAULT TABLE FOR NONGLAZED DOORS

DOOR TYPE	WITH FOAM CORE 0.35	WITHOUT FOAM CORE 0.60
Steel doors (1.75 inches thick)	WITHOUT STORM DOOR	WITH STORM DOOR
<b>Wood doors (1.75 inches thick)</b>		
Panel with 0.438 inch panels	0.54	0.36

ONE AND TWO FAMILY DWELLING CODE

Hollow core flush	0.46	0.32
Panel with 1.125 inch panels	0.39	0.28
Solid core flush	0.40	0.26

For SI: 1 inch = 25.4 mm.

TABLE 11-3  
SHGC DEFAULT TABLE FOR FENESTRATION

PRODUCT DESCRIPTION	SINGLE GLAZED				DOUBLE GLAZED			
	Clear	Bronze	Green	Gray	Clear + Clear	Bronze + Clear	Green + Clear	Gray + Clear
<b>Metal frames</b>								
Operable	0.75	0.64	0.62	0.61	0.66	0.55	0.53	0.52
Fixed	0.78	0.67	0.65	0.64	0.68	0.57	0.55	0.54
<b>Nonmetal frames</b>								
Operable	0.63	0.54	0.53	0.52	0.55	0.46	0.45	0.44
Fixed	0.75	0.64	0.62	0.61	0.66	0.54	0.53	0.52

N1101.3.2.2 Air leakage. The air leakage of prefabricated fenestration shall be determined by the manufacturer. Alternatively, the fenestration shall be installed in accordance with the maximum allowable rates in TABLE 11-4.

EXCEPTION: Site-constructed windows and doors sealed in accordance with SECTION N1102.1.10.

TABLE 11-4  
ALLOWABLE AIR FILTRATION RATES<sup>a</sup>

WINDOWS (cfm per square foot of window area)	DOORS (cfm per square foot of door area)	
	Sliders	Swinging
0.3 <sup>b</sup>	0.3	0.5

For SI: 1 cfm/ft<sup>2</sup> = 0.00508 m<sup>3</sup>/(s × m<sup>2</sup>).

<sup>a</sup>When tested in accordance with NFRC 400.

<sup>b</sup>See AAMA/WDMA 101/I.S. 2.

N1101.3.3 MINIMUM INSULATION R-VALUES. The minimum insulation R-values permitted using tradeoffs from SECTION N1103 or SECTION N1106 for all climate regions shall be R-13 for abovegrade walls, R-30 for ceilings, and R-19 for floors.

N1101.4 Alternate energy materials, methods, and design. The provisions of this code are not intended to prevent the use of any material, method of construction, design, or insulating system not specifically prescribed herein, provided that such construction, design, or insulating system has been approved as meeting the intent of the code.

Compliance with specific provisions and the intent of this code shall be determined through the use of approved computer software (such as REScheck or MECcheck provided by the Department of Energy), worksheets, compliance manuals (from ASTM, etc.), and other similar materials.

**SECTION N1102 COMPLIANCE BY PRESCRIPTIVE SPECIFICATIONS ON INDIVIDUAL COMPONENTS**

N1102.1 Thermal performance criteria. The minimum required insulation R-value or maximum required U-factor for each element in the building thermal envelope (fenestration, roof/ceiling, opaque wall, floor, slab edge, crawlspace wall, and basement wall) shall be in accordance with criteria in TABLE 11-5.

TABLE 11-5  
INSULATION AND FENESTRATION REQUIREMENTS BY COMPONENTS<sup>a</sup>  
78% AFUE or 6.8 HSPF and 10 SEER

REGION See Figure 11-1	GLAZING U-VALUE	SKYLIGHT U-VALUE <sup>b</sup>	CEILING R- VALUE	WALL R- VALUE <sup>ce</sup>	FLOOR R- VALUE <sup>d</sup>	BASEMENT WALL R-VALUE <sup>e</sup>	SLAB PERIMETER R-VALUE/DEPTH <sup>f</sup>	CRAWLSPACE WALL R-VALUE <sup>e</sup>
North	.35	0.60	30	15 plus 1	25	13 / 7 ft.	10 / 4 ft.	7 / 3.2 ft.
Central	.45	0.60	30	13 plus 1	25	10 / 7 ft.	10 / 4 ft.	10 / 2.7 ft.
South	.45	0.60	30	13 plus 1	19	7 / 7 ft.	7 / 3 ft.	7 / 2.7 ft.
Ohio River	.45	0.60	30	13	19	7 / 4 ft.	3.5 / 2 ft.	3 / 2.2 ft.

<sup>a</sup>R-values are minimums. U-factors and SHGC are maximums. R-19 insulation shall be permitted to be compressed except as noted. The glazing U-factors are for windows only. The default U-factors for doors are in TABLES 11-1 and 11-2. The maximum door U-values to be allowed with this table are as follows: main exit, 0.54; other exit doors, 0.34; sliding glass doors, French doors, and atrium doors, 0.55.

<sup>b</sup>Skylights are glazed fenestration less than 60 degrees from horizontal.

<sup>c</sup>Cavity insulation plus sheathing (wood frame walls only). Steel frame walls require the installation of an exterior insulated sheathing in accordance with SECTION N1102.1.12.

<sup>d</sup>Or insulation sufficient to fill the cavity, R-19 minimum.

<sup>e</sup>Box or rim joist cavity spaces must be insulated R-22 minimum, entire exterior perimeter.

<sup>f</sup>The insulation shall be installed from the top of the slab to the required depth, horizontally or vertically, or a combination of both, until the required depth is achieved.

N1102.1.1 Exterior walls. The minimum required R-value in TABLES 11-5 shall be met by the sum of the R-values of the insulation materials installed in framing cavities and/or sheathing applied and not by framing, drywall, or exterior siding materials. Insulation separated from the conditioned space by a vented space shall not be counted towards the required R-value.

N1102.1.1.1 Mass walls. For purposes of this section, the following definitions apply: Mass walls with exterior insulation position are those that have the entire effective mass layer interior to an insulation layer. Mass walls with integral insulation position are those that have either insulation and mass materials well mixed as in wood (logs) or substantially equal amounts of mass material on the interior and exterior of insulation as in concrete masonry units with insulated cores or masonry cavity walls. Mass walls with interior insulation position are those that have the mass material located exterior to the insulating material.

Mass walls shall be permitted to meet the mass wall criteria in TABLE 11-6 based on the insulation position and the climate zone where the building is located. Other mass walls shall meet the frame wall criteria for the building type and the climate zone where the building is located based on the sum of interior and exterior insulation.

Mass walls not meeting either of the above descriptions for exterior or integral positions shall meet the requirements for other mass walls in TABLE 11-6. The R-value for a solid concrete wall with a thickness of 4 inches (102 mm) or greater is R-1.1. R-values for other assemblies are permitted to be based on hot box tests.

TABLE 11-6  
MASS WALL PRESCRIPTIVE BUILDING ENVELOPE REQUIREMENTS

Building Location		Mass Wall Assembly R-Value (hr ft <sup>2</sup> F)/Btu	
Zone	HDD	Exterior or Integral Insulation	Other Mass Walls
Northern	6,300	R-13	R-15.2
Central	5,700	R-13	R-15.2
South	5,000	R-8	R-15.2
Ohio River	4,300	R-8	R-15.2

For SI: 1(hr ft<sup>2</sup>F)/Btu = 0.176 m<sup>2</sup> K/W

N1102.1.1.2. Steel-frame walls. When steel framing construction is used, insulated sheathing with an R-5 value shall be installed in addition to the minimum required R-value for frame walls determined in accordance with TABLE 11-5.

N1102.1.2 Ceilings. The required "Ceiling R-value" in TABLE 11-5 assumes standard truss or rafter construction and shall apply to all roof/ceiling portions of the building thermal envelope including cathedral ceilings. R-30 shall be permitted to be compressed over the top plate to obtain the required rafter air spaces. R-30 shall be permitted to be used over the top plate where R-38 is required. R-38 shall be permitted over the top plate where R-49 is required.

N1102.1.3 Opaque doors. Opaque doors separating conditioned and unconditioned space shall have a maximum U-factor of 0.35. One opaque door shall be permitted to be exempt from this U-factor requirement.

N1102.1.4 Floors. The required R-value in TABLE 11-5 shall apply to all floors, except any individual floor assembly with over 25 percent of its conditioned floor area exposed directly to outside air shall meet the R-value requirement in TABLE 11-5 for ceilings.

N1102.1.5 Basement walls. When insulating basement walls, the required R-values shall be applied from the top of the basement wall to the depth required by TABLE 11-5.

N1102.1.6 Slab-on-grade floors. For slabs with a top edge 8 inches (203 mm) or less above or 12 inches (305 mm) or less below finished grade, the required R-value in TABLE 11-5 shall be applied to the outside of the foundation or the inside of the foundation wall. The insulation shall extend downward from the top of the slab, or downward to the bottom of the slab and then horizontally



in either direction, for the minimum distance listed in TABLE 11-5.

When installed between the exterior wall and the edge of the interior slab, the top edge of the insulation shall be permitted to be cut at a 45 degree (0.79 radians) angle away from the exterior wall. Insulation extending horizontally away from the building shall be protected as set forth by SECTION R403.3.1.

R-2 shall be added to the values in TABLE 11-5 where uninsulated hot water pipes, air distribution ducts, or electric heating cables are installed within or under the slab.

N1102.1.7 Crawlspace walls. Where the floor above the crawlspace is uninsulated, and the crawlspace is not vented to outside air, insulation shall be installed on crawlspace walls as required in TABLE 11-5. The insulation shall be applied inside of the crawlspace wall, downward from the sill plate to the distance required by TABLE 11-5. The exposed earth in all crawlspace foundations shall be covered with a continuous 6 mil vapor retarder having a maximum permance rating of 1.0 perm ( $5.74525 \times 10^{-11}$  kg/(Pa  $\times$  s  $\times$  m<sup>2</sup>)).

N1102.1.8 Masonry veneer. For exterior foundation insulation, that horizontal portion of the foundation that supports a masonry veneer shall not be required to be insulated.

N1102.1.9 Protection. Exposed insulating materials applied to the exterior of foundation walls shall be protected from damage or deterioration. The protection shall extend at least 6 inches (152 mm) below finished grade level.

N1102.1.10 Air leakage. Exterior joints, seams, or penetrations in the building envelope that are sources of air leakage shall be sealed with caulking materials, closed with gasketing systems, taped, or covered with moisture vapor-permeable house-wrap. Sealing materials spanning joints between dissimilar construction materials shall allow for differential expansion and contraction of the construction materials. This includes sealing around tubs and showers, at the attic and crawlspace panels, at recessed lights, and around all plumbing and electrical penetrations. These are openings located in the building envelope between conditioned space and unconditioned space or between the conditioned space and the outside.

EXCEPTION: Vertical seams and joints with gaps of 1/8 inch (3 mm) or less that break over a stud.

N1102.1.11 Recessed lighting fixtures. When installed in the building envelope, recessed lighting fixtures shall meet one of the following:

1. Type IC rated, manufactured with no penetrations between the inside of the recessed fixture and ceiling cavity and sealed or gasketed to prevent air leakage into the unconditioned space.
2. Type IC or non-IC rated, installed inside a sealed box constructed from a minimum 0.5 inch (12.7 mm) thick gypsum wallboard or constructed from a preformed polymeric vapor barrier, or other airtight assembly manufactured for this purpose, while maintaining required clearances of not less than 0.5 inch (12.7 mm) from combustible material and not less than 3 inches (76 mm) from insulation material.
3. Type IC rated admitting no more than 2.0 cubic feet per minute (cfm) (0.944L/s) of air movement from the conditioned space to the ceiling cavity. The lighting fixture shall be tested at 1.57 psi (75 Pa) pressure difference and shall be labeled.

N1102.2 Fenestration exemption. Up to 1 percent of the total glazing area shall be exempt from U-factor requirements.

SECTION N1103 COMPLIANCE BY TOTAL BUILDING ENVELOPE PERFORMANCE

N1103.1 Compliance with this section is an alternative to compliance with SECTION N1102.

N1103.2 Compliance by total building envelope performance. The building envelope design of a proposed building shall be permitted to deviate from the U<sub>o</sub>-factors, U-factors, or R-values specified in TABLE 11-7, provided the total thermal transmission heat gain or loss for the proposed building envelope does not exceed the total heat gain or loss resulting from the proposed building's conformance to the values specified in TABLE 11-7. For basement and crawlspace walls that are part of the building envelope, the U-factor of the proposed foundation shall be adjusted by the R-value of the adjacent soil where the corresponding U-factor in TABLE 11-7 is similarly adjusted. Heat gain or loss calculations for slab edge and basement or crawlspace wall foundations shall be determined using approved methods.

TABLE 11-7<sup>a, b, c</sup>  
EQUIVALENT U-FACTORS

REGION	GLAZING	SKYLIGHT	CEILING	WALL	MASS WALL	FLOOR	BASEMENT	SLAB PERIMETER	CRAWLSPACE
North	0.35	0.60	0.035	0.064	0.077	0.037	0.055	0.684	0.076
Central	0.45	0.60	0.035	0.074	0.077	0.042	0.064	0.684	0.100
South	0.45	0.60	0.035	0.074	0.125	0.045	0.078	0.727	0.109
Ohio River	0.45	0.60	0.035	0.077	0.125	0.047	0.093	0.825	0.196

ONE AND TWO FAMILY DWELLING CODE

<sup>a</sup>Nonfenestration U-factors shall be obtained from this table, measurement, calculation, or an approved source.

<sup>b</sup>For 78 percent AFUE furnaces or 6.8 HSPF and 10 SEER except where otherwise noted.

<sup>c</sup>The maximum door U-values to be allowed with this table are as follows: main exit, 0.54; other exit doors, 0.34; sliding glass doors, French doors, and atrium doors, 0.55.

**SECTION N1104 MECHANICAL SYSTEMS**

N1104.1 Heating and air conditioning appliance and equipment performance. Performance of equipment listed in TABLE 11-8 is covered by preemptive federal law. Appliances and equipment not listed in TABLE 11-8 shall be approved. Data furnished by the equipment supplier, or certified under a nationally recognized certification procedure, shall be used to satisfy these requirements. All such equipment shall be installed in accordance with the manufacturer’s instructions.

TABLE 11-8  
MINIMUM EQUIPMENT PERFORMANCE

EQUIPMENT CATEGORY	SUBCATEGORY <sup>e</sup>	REFERENCED STANDARD	MINIMUM PERFORMANCE
Air-cooled heat pumps heating mode < 65,000 Btu/h cooling capacity	Split systems	ARI 210/240	6.8 HSPF <sup>a, b</sup>
	Single package		6.6 HSPF <sup>a, b</sup>
Gas-fired or oil-fired furnace < 225,000 Btu/h		DOE 10 CFR Part 430, Subpart B, APPENDIX N	AFUE 78% <sup>b</sup> Et 80% <sup>c</sup>
Gas-fired or oil-fired steam and hot water boilers < 300,000 Btu/h		DOE 10 CFR Part 430, Subpart B, APPENDIX N	AFUE 78% <sup>b, d</sup>
Air-cooled air conditioners and heat pumps cooling mode < 65,000 Btu/h cooling capacity	Split systems	ARI 210/240	10.0 SEER <sup>b</sup>
	Single package		9.7 SEER <sup>b</sup>

For SI: 1 Btu/h = 0.2931 W.

<sup>a</sup>For multicapacity equipment, the minimum performance shall apply to each capacity step provided. Multicapacity refers to manufacturer-published ratings for more than one capacity mode allowed by the product’s controls.

<sup>b</sup>This is used to be consistent with the National Appliance Energy Conservation Act (NAECA) of 1987 (Public Law 100-12).

<sup>c</sup>These requirements apply to combination units not covered by NAECA (three-phase power or cooling capacity 65,000 Btu/h).

<sup>d</sup>Except for gas-fired steam boilers, for which the minimum AFUE shall be 75 percent.

<sup>e</sup>Seasonal rating.

N1104.2 Controls. At least one thermostat shall be provided for each separate heating, cooling, or combination heating and cooling system. Heat pumps shall have controls that prevent supplementary electric resistance heater operation when the heating load can be met by the heat pump alone. Supplementary heater operation shall be permitted during outdoor coil defrost cycles not exceeding 15 minutes.

N1104.3 Duct insulation. All portions of the air distribution system that serve the permanent heating, ventilating, and air conditioning systems shall be installed in accordance with SECTION M1601 and be insulated to an installed R-4.2 when system components are located within the building but outside of conditioned space and R-8 when located outside of the building. When located within a building envelope assembly, at least R-8 shall be applied between the duct and that portion of the assembly furthest from conditioned space.

EXCEPTION: Exhaust air ducts and portions of the air distribution system within appliances or equipment.

N1104.4 Duct sealing. All ducts shall be sealed in accordance with SECTION M1601.3.1.

N1104.5 Piping insulation. All mechanical system piping that serves the permanent heating, ventilating, and air conditioning systems shall be insulated in accordance with TABLE 11-9.

EXCEPTION: Piping installed within appliances and equipment or piping serving fluids between 55°F (13°C) and 120°F (49°C).

TABLE 11-9  
MINIMUM HVAC PIPING INSULATION THICKNESSES<sup>a</sup>

	FLUID TEMPERATURE RANGE (°F)	INSULATION THICKNESS (inches) <sup>b</sup>

ONE AND TWO FAMILY DWELLING CODE

HEATING SYSTEMS		
Low pressure/temperature	201–250	1.5
Low temperature	120–200	1.0
Steam condensate (for feed water)	Any	1.5
COOLING SYSTEMS		
Chilled water, refrigerant, or brine	40–55	0.75
	Below 40	1.25

For SI: 1 inch = 25.4 mm, °C = (°F - 32)/1.8.

<sup>a</sup>The pipe insulation thicknesses specified in this table are based on insulation R-values ranging from R-4 to R-4.6 per inch of thickness. For materials with an R-value greater than R-4.6, the insulation thickness specified in this table may be reduced as follows:

$$\text{New Minimum Thickness} = \frac{4.6 \times \text{Table Thickness}}{\text{Actual R-value}}$$

For materials with an R-value less than R-4, the minimum insulation thickness shall be increased as follows:

$$\text{New Minimum Thickness} = \frac{4.0 \times \text{Table Thickness}}{\text{Actual R-value}}$$

<sup>b</sup>For piping exposed to outdoor air, increase thickness by 0.5 inch.

**SECTION N1105 SERVICE WATER HEATING**

N1105.1 Water heating appliance and equipment performance. Performance of equipment listed in TABLE 11-10 is covered by preemptive federal law. Appliances and equipment not listed in TABLE 11-10 shall be approved.

TABLE 11-10

**REQUIRED PERFORMANCE OF DOMESTIC HOT WATER HEATING EQUIPMENT SUBJECT TO MINIMUM FEDERAL STANDARDS**

CATEGORY	MAXIMUM INPUT RATING	MINIMUM EFFICIENCY
Electric; storage or instantaneous	12 kW	0.93 - 0.00132 × V <sup>a</sup>
Gas; storage	75,000 Btu/h	0.62 - 0.0019 × V <sup>a</sup>
Gas; instantaneous	200,000 Btu/h	0.62 - 0.0019 × V <sup>a</sup>
Oil; storage	105,000 Btu/h	0.59 - 0.0019 × V <sup>a</sup>
Oil; instantaneous	210,000 Btu/h	0.59 - 0.0019 × V <sup>a</sup>

For SI: 1Btu/h = 0.2931 W, 1 gallon = 3.785 L.

<sup>a</sup>V is the rated storage volume in gallons as specified by the manufacturer.

**N1106 ALTERNATE DESIGN**

N1106.1 Chapter 4, Residential Building Design by Systems Analysis and Design of Buildings Utilizing Renewable Energy Sources, of the International Energy Conservation Code 2000, except as amended in subsection N1106.2, is an alternative to compliance with SECTIONS N1102 AND N1103.

N1106.2 (a) Change subsection 402.1 to read as follows: Compliance with this chapter will require an analysis of the annual energy usage, completed during the building design phase, and hereinafter called the “annual energy analysis”.

(b) Delete the exception from subsection 402.1 without substitution.

(c) Delete “Chapter 5” from subsection 402.1.1 and substitute “TABLE 11-5, TABLE 11-7, or TABLE 11-11”. Delete all exceptions in subsection 402.1.1.

(d) Delete TABLES 402.1.1(1) and 402.1.1(2) including their footnotes.

(e) In subsection 402.1.3.1.4, delete “Table 102.5.2(3)” and substitute “TABLE 11-3”.

(f) In subsection 402.1.3.6, delete “Type A-1 Residential building” and substitute “1 or 2 family dwelling” and delete “Type A-2 Residential building” and substitute “townhouse”.

(g) Add the following to the last sentence of subsection 402.1.3.10: “See subsection R303.1 for ventilation requirements for one and two family dwellings or townhouses.”.

(h) In subsection 402.1.3.11, delete “Table 502.2” and substitute “TABLE 11-5”.

(i) In subsection 402.4.1, delete “as required in Chapter 3” and substitute “as follows:” and the following table:

ONE AND TWO FAMILY DWELLING CODE

TABLE 11-11  
THERMAL DESIGN PARAMETERS EXTERNAL DESIGN CONDITIONS

	Northern	Central	South	Ohio River
WINTER Design Dry-Bulb °F	1°	2°	9°	9°
SUMMER Design Wet-Bulb °F	73°	74°	75°	75°
SUMMER Design Dry-Bulb °F	89°	90°	93°	93°
DEGREE DAYS HEATING	6,300	5,700	5,000	4,300

(j) In subsection 402.5, delete “Chapter 4” and substitute “this chapter”.

(k) In subsection 403.1.1.1, delete “Section 502.1.4.1” and substitute “TABLE 11-4”. (*Fire Prevention and Building Safety Commission; 675 IAC 14-4.3-139; filed Jun 13, 2005, 3:00 p.m.: 28 IR 3282, eff 90 days after filing with the Secretary of State*)

**675 IAC 14-4.3-140 Section M1201.1; scope**

Authority: IC 22-13-2-2; IC 22-13-2-13

Affected: IC 22-12; IC 22-13; IC 22-14; IC 22-15; IC 36-7

Sec. 140. Change SECTION M1201.1 to read as follows: The provisions of Chapters 1, 2, and 12 through 24 shall regulate the design, installation, and alteration of any part of the permanent heating, ventilating, and air conditioning for a Class 1 structure-townhouse or a Class 2 structure-1 or 2 family dwelling. (*Fire Prevention and Building Safety Commission; 675 IAC 14-4.3-140; filed Jun 13, 2005, 3:00 p.m.: 28 IR 3289, eff 90 days after filing with the Secretary of State*)

**675 IAC 14-4.3-141 Section M1201.2; application**

Authority: IC 22-13-2-2; IC 22-13-2-13

Affected: IC 22-12; IC 22-13; IC 22-14; IC 22-15; IC 36-7

Sec. 141. Delete SECTION M1201.2. (*Fire Prevention and Building Safety Commission; 675 IAC 14-4.3-141; filed Jun 13, 2005, 3:00 p.m.: 28 IR 3289, eff 90 days after filing with the Secretary of State*)

**675 IAC 14-4.3-142 Section M1202; existing mechanical systems**

Authority: IC 22-13-2-2; IC 22-13-2-13

Affected: IC 22-12; IC 22-13; IC 22-14; IC 22-15; IC 36-7

Sec. 142. Delete SECTION M1202 and substitute to read as follows: For existing installations see Chapter 1 and the General Administrative Rules (675 IAC 12). (*Fire Prevention and Building Safety Commission; 675 IAC 14-4.3-142; filed Jun 13, 2005, 3:00 p.m.: 28 IR 3289, eff 90 days after filing with the Secretary of State*)

**675 IAC 14-4.3-143 Section M1303.1; label information**

Authority: IC 22-13-2-2; IC 22-13-2-13

Affected: IC 22-12; IC 22-13; IC 22-14; IC 22-15; IC 36-7

Sec. 143. Change, in SECTION M1303.1, Item 4, “approval” to “acceptance”. (*Fire Prevention and Building Safety Commission; 675 IAC 14-4.3-143; filed Jun 13, 2005, 3:00 p.m.: 28 IR 3289, eff 90 days after filing with the Secretary of State*)

**675 IAC 14-4.3-144 Section M1307.3.1; protection from impact**

Authority: IC 22-13-2-2; IC 22-13-2-13

Affected: IC 22-12; IC 22-13; IC 22-14; IC 22-15; IC 36-7

Sec. 144. Delete SECTION M1307.3.1. (*Fire Prevention and Building Safety Commission; 675 IAC 14-4.3-144; filed Jun 13, 2005, 3:00 p.m.: 28 IR 3289, eff 90 days after filing with the Secretary of State*)

**675 IAC 14-4.3-145 Section M1411.3.1; auxiliary and secondary drain systems**

Authority: IC 22-13-2-2; IC 22-13-2-13

Affected: IC 22-12; IC 22-13; IC 22-14; IC 22-15; IC 36-7

Sec. 145. (a) In the first sentence of SECTION M1411.3.1 delete “damage to any building components will occur as a result of overflow from the equipment drain pan or stoppage in the condensate drain piping” and insert “installed over a finished ceiling”.

(b) Add an exception to the end of SECTION M1411.3.1 to read as follows: EXCEPTION: When installed on a water-resistant floor with a floor drain in the same room or space. *(Fire Prevention and Building Safety Commission; 675 IAC 14-4.3-145; filed Jun 13, 2005, 3:00 p.m.: 28 IR 3289, eff 90 days after filing with the Secretary of State)*

**675 IAC 14-4.3-146 Section M1501.3; length limitation**

Authority: IC 22-13-2-2; IC 22-13-2-13

Affected: IC 22-12; IC 22-13; IC 22-14; IC 22-15; IC 36-7

Sec. 146. Change, in the first sentence of SECTION M1501.3, “25 feet (7,620 mm)” to read “35 feet”. *(Fire Prevention and Building Safety Commission; 675 IAC 14-4.3-146; filed Jun 13, 2005, 3:00 p.m.: 28 IR 3290, eff 90 days after filing with the Secretary of State)*

**675 IAC 14-4.3-147 Section M2001.1; installation**

Authority: IC 22-13-2-2; IC 22-13-2-13

Affected: IC 22-12; IC 22-13-2-9; IC 22-14; IC 22-15; IC 36-7

Sec. 147. Add SECTION M2001.1.2 to the end of SECTION M2001 to read as follows: Boilers and water heaters regulated by the Boiler and Pressure Vessel Rules Board (680 IAC 2) under IC 22-13-2-9 are not regulated by this code. *(Fire Prevention and Building Safety Commission; 675 IAC 14-4.3-147; filed Jun 13, 2005, 3:00 p.m.: 28 IR 3290, eff 90 days after filing with the Secretary of State)*

**675 IAC 14-4.3-148 Section M2005.5; anchorage of water heaters in Seismic Design Category C<sub>1</sub>**

Authority: IC 22-13-2-2; IC 22-13-2-13

Affected: IC 22-12; IC 22-13; IC 22-14; IC 22-15; IC 36-7

Sec. 148. Add SECTION M2005.5 to the end of SECTION M2005 to read as follows: M2005.5 Anchorage of Water Heaters in Seismic Design Category C<sub>1</sub>. In Seismic Design Category C<sub>1</sub>, all gas water heaters shall be anchored or fastened to resist horizontal displacement due to earthquake motion as provided in SECTION M1307.2.

EXCEPTION: Where approved excessive flow valves are implemented for the entire dwelling unit or for each gas appliance. *(Fire Prevention and Building Safety Commission; 675 IAC 14-4.3-148; filed Jun 13, 2005, 3:00 p.m.: 28 IR 3290, eff 90 days after filing with the Secretary of State)*

**675 IAC 14-4.3-149 Section M2201.3; underground tanks**

Authority: IC 22-13-2-2; IC 22-13-2-13

Affected: IC 22-12; IC 22-13; IC 22-14; IC 22-15; IC 36-7

Sec. 149. Delete SECTION M2201.3 and substitute to read as follows: Excavations for underground tanks shall not undermine the foundations of existing structures.

Underground tanks shall be set on firm foundations and surrounded with at least 6 inches (152.4 mm) of noncorrosive inert material, such as clean sand or gravel well-tamped in place or in accordance with the manufacturer’s installation instructions. Tanks shall be covered with a minimum of 2 feet (609.6 mm) of earth or shall be covered by not less than 1 foot (304.8 mm) of earth, on top of which shall be placed a slab of reinforced concrete not less than 4 inches (101.6 mm) thick.

When underground tanks are, or are likely to be, subjected to traffic, they shall be protected against damage from vehicles passing over them by at least 3 feet (914.4 mm) of earth cover, or 18 inches (457.2 mm) of well-tamped earth plus 6 inches (152.4 mm) of reinforced concrete, or 8 inches (203.2 mm) of asphaltic concrete. When asphaltic or reinforced concrete paving is used as part of

the protection, it shall extend at least 1 foot (304.8 mm) horizontally beyond the outline of the tank in all directions. The clearance from the tank to the nearest wall of a basement, pit, or property line shall not be less than 1 foot (305 mm). Corrosion protection shall be provided in accordance with SECTION M2203.7. *(Fire Prevention and Building Safety Commission; 675 IAC 14-4.3-149; filed Jun 13, 2005, 3:00 p.m.: 28 IR 3290, eff 90 days after filing with the Secretary of State)*

**675 IAC 14-4.3-150 Section M2301.1; general**

Authority: IC 22-13-2-2; IC 22-13-2-13

Affected: IC 22-12; IC 22-13; IC 22-14; IC 22-15; IC 36-7

Sec. 150. Change SECTION M2301.1 to read as follows: This section provides for the construction, installation, and alteration of equipment and systems utilizing solar energy to provide space heating or cooling and hot water heating. *(Fire Prevention and Building Safety Commission; 675 IAC 14-4.3-150; filed Jun 13, 2005, 3:00 p.m.: 28 IR 3290, eff 90 days after filing with the Secretary of State)*

**675 IAC 14-4.3-151 Section G2401.1; application**

Authority: IC 22-13-2-2; IC 22-13-2-13

Affected: IC 22-12; IC 22-13; IC 22-14; IC 22-15; IC 36-7

Sec. 151. Delete, in the second sentence of the second paragraph of SECTION G2401.1, “, inspection, operation, and maintenance” and add “and” before “testing” and delete the comma after “installation”. *(Fire Prevention and Building Safety Commission; 675 IAC 14-4.3-151; filed Jun 13, 2005, 3:00 p.m.: 28 IR 3290, eff 90 days after filing with the Secretary of State)*

**675 IAC 14-4.3-152 Section G2403; general definitions**

Authority: IC 22-13-2-2; IC 22-13-2-13

Affected: IC 22-12; IC 22-13-2-9; IC 22-14; IC 22-15; IC 36-7

Sec. 152. Change SECTION G2403 as follows: (a) Change the title to read as follows: SECTION G2403(202) GENERAL DEFINITIONS FOR THE PURPOSE OF CHAPTER 24 ONLY.

(b) Add to the end of the definition of BOILER, LOW PRESSURE as follows: This definition is not applicable to boilers regulated by the Boiler and Pressure Vessel Rules Board (680 IAC 2) under IC 22-13-2-9.

(c) Delete the definition of CODE.

(d) Delete the definition of CODE OFFICIAL and substitute to read as follows: See BUILDING OFFICIAL in SECTION R202.

(e) Delete the definition of HAZARDOUS LOCATION.

(f) Add, after “MODULATING”, “NFPA 58. See 675 IAC 22-2.2-14”.

(g) Add, after “UNIT HEATER”, “UNUSUALLY TIGHT CONSTRUCTION. See SECTION R202”. *(Fire Prevention and Building Safety Commission; 675 IAC 14-4.3-152; filed Jun 13, 2005, 3:00 p.m.: 28 IR 3290, eff 90 days after filing with the Secretary of State)*

**675 IAC 14-4.3-153 Section G2404.7; flood hazard**

Authority: IC 22-13-2-2; IC 22-13-2-13

Affected: IC 22-12; IC 22-13; IC 22-14; IC 22-15; IC 36-7

Sec. 153. Delete SECTION G2404.7 and substitute to read as follows: See local ordinance. *(Fire Prevention and Building Safety Commission; 675 IAC 14-4.3-153; filed Jun 13, 2005, 3:00 p.m.: 28 IR 3291, eff 90 days after filing with the Secretary of State)*

**675 IAC 14-4.3-154 Section G2405.1; structural safety**

Authority: IC 22-13-2-2; IC 22-13-2-13

Affected: IC 22-12; IC 22-13; IC 22-14; IC 22-15; IC 36-7

Sec. 154. Delete, in the second sentence of SECTION G2405.1, “repairing” and substitute “altering”. (*Fire Prevention and Building Safety Commission; 675 IAC 14-4.3-154; filed Jun 13, 2005, 3:00 p.m.: 28 IR 3291, eff 90 days after filing with the Secretary of State*)

**675 IAC 14-4.3-155 Section G2408.1; general**

Authority: IC 22-13-2-2; IC 22-13-2-13

Affected: IC 22-12; IC 22-13; IC 22-14; IC 22-15; IC 36-7

Sec. 155. Make the following changes to SECTION G2408.1: (a) Delete, at the end of the second sentence, “at the time of inspection”.

(b) Delete, at the end of the second paragraph, “and the requirements determined by the code official”.

(c) In the second paragraph, add “and” after “instructions” and before “the”. (*Fire Prevention and Building Safety Commission; 675 IAC 14-4.3-155; filed Jun 13, 2005, 3:00 p.m.: 28 IR 3291, eff 90 days after filing with the Secretary of State*)

**675 IAC 14-4.3-155.5 Section G2411.1; gas pipe bonding**

Authority: IC 22-13-2-2; IC 22-13-2-13

Affected: IC 22-12; IC 22-13; IC 22-14; IC 22-15; IC 36-7

Sec. 155.5. Delete the text of SECTION G2411.1 and add text to read as follows: All metal gas piping upstream from the equipment shutoff valve(s) shall be electrically continuous and shall be bonded to an effective ground-fault current path in accordance with SECTION E3509.7. Except where connected to appliances and at bonding connections, flexible metal gas piping shall be isolated from metal water piping, metal air ducts, and all electrical wiring methods by a space separation of at least 2 inches. (*Fire Prevention and Building Safety Commission; 675 IAC 14-4.3-155.5; filed Oct 21, 2005, 1:50 p.m.: 29 IR 806*)

**675 IAC 14-4.3-156 Section G2408.3; private garages**

Authority: IC 22-13-2-2; IC 22-13-2-13

Affected: IC 22-12; IC 22-13; IC 22-14; IC 22-15; IC 36-7

Sec. 156. Delete SECTION G2408.3. (*Fire Prevention and Building Safety Commission; 675 IAC 14-4.3-156; filed Jun 13, 2005, 3:00 p.m.: 28 IR 3291, eff 90 days after filing with the Secretary of State*)

**675 IAC 14-4.3-157 Section G2412.1; scope**

Authority: IC 22-13-2-2; IC 22-13-2-13

Affected: IC 22-12; IC 22-13; IC 22-14; IC 22-15; IC 36-7

Sec. 157. Change SECTION G2412.1 to read as follows: This chapter shall govern the design, installation, and modification of piping systems. The applicability of this code to piping systems extends from the point of delivery to the connections with the equipment and includes the design, materials, components, fabrication, assembly, installation, and testing of such piping systems. (*Fire Prevention and Building Safety Commission; 675 IAC 14-4.3-157; filed Jun 13, 2005, 3:00 p.m.: 28 IR 3291, eff 90 days after filing with the Secretary of State*)

**675 IAC 14-4.3-158 Section G2412.1.1; utility piping systems located within buildings**

Authority: IC 22-13-2-2; IC 22-13-2-13

Affected: IC 22-12; IC 22-13; IC 22-14; IC 22-15; IC 36-7

Sec. 158. Delete SECTION G2412.1.1. (*Fire Prevention and Building Safety Commission; 675 IAC 14-4.3-158; filed Jun 13, 2005, 3:00 p.m.: 28 IR 3291, eff 90 days after filing with the Secretary of State*)

**675 IAC 14-4.3-159 Section G2413.2; maximum gas demand**

Authority: IC 22-13-2-2; IC 22-13-2-13

Affected: IC 22-12; IC 22-13; IC 22-14; IC 22-15; IC 36-7

Sec. 159. Delete, in the last sentence of the first paragraph of SECTION G2413.2, “a qualified” and substitute “an approved”. *(Fire Prevention and Building Safety Commission; 675 IAC 14-4.3-159; filed Jun 13, 2005, 3:00 p.m.: 28 IR 3291, eff 90 days after filing with the Secretary of State)*

**675 IAC 14-4.3-160 Section G2414.3; other materials**

Authority: IC 22-13-2-2; IC 22-13-2-13  
Affected: IC 22-12; IC 22-13; IC 22-14; IC 22-15; IC 36-7

Sec. 160. Change “code official” to “building official”. *(Fire Prevention and Building Safety Commission; 675 IAC 14-4.3-160; filed Jun 13, 2005, 3:00 p.m.: 28 IR 3291, eff 90 days after filing with the Secretary of State)*

**675 IAC 14-4.3-161 Section G2415.8; protection against corrosion**

Authority: IC 22-13-2-2; IC 22-13-2-13  
Affected: IC 22-12; IC 22-13; IC 22-14; IC 22-15; IC 36-7

Sec. 161. Change, in the third sentence of SECTION G2415.8, “in a manner satisfactory to the code official” to read “as approved by the building official”. *(Fire Prevention and Building Safety Commission; 675 IAC 14-4.3-161; filed Jun 13, 2005, 3:00 p.m.: 28 IR 3292, eff 90 days after filing with the Secretary of State)*

**675 IAC 14-4.3-162 Section G2415.9.1; individual outside appliances**

Authority: IC 22-13-2-2; IC 22-13-2-13  
Affected: IC 22-12; IC 22-13; IC 22-14; IC 22-15; IC 36-7

Sec. 162. Delete SECTION G2415.9.1. *(Fire Prevention and Building Safety Commission; 675 IAC 14-4.3-162; filed Jun 13, 2005, 3:00 p.m.: 28 IR 3292, eff 90 days after filing with the Secretary of State)*

**675 IAC 14-4.3-163 Section G2415.16; testing of piping**

Authority: IC 22-13-2-2; IC 22-13-2-13  
Affected: IC 22-12; IC 22-13; IC 22-14; IC 22-15; IC 36-7

Sec. 163. Delete, in the last sentence of SECTION G2415.16, “, inspection”. *(Fire Prevention and Building Safety Commission; 675 IAC 14-4.3-163; filed Jun 13, 2005, 3:00 p.m.: 28 IR 3292, eff 90 days after filing with the Secretary of State)*

**675 IAC 14-4.3-164 Section G2417; inspection, testing, and purging**

Authority: IC 22-13-2-2; IC 22-13-2-13  
Affected: IC 22-12; IC 22-13; IC 22-14; IC 22-15; IC 36-7

Sec. 164. Change SECTION G2417 as follows: (a) Change the title to read as follows: SECTION G2417 (406) TESTING AND PURGING.

(b) Delete, in SECTION G2417.1, “inspected and”.

(c) Delete SECTION G2417.1.1.

(d) Change the title and text of SECTION G2417.1.2 to read as follows: Additions. In the event additions are made following the pressure test, the affected piping shall be tested.

EXCEPTION: Minor additions, provided the work and connections are tested with a noncorrosive leak-detecting fluid or other leak-detecting methods approved by the building official.

*(Fire Prevention and Building Safety Commission; 675 IAC 14-4.3-164; filed Jun 13, 2005, 3:00 p.m.: 28 IR 3292, eff 90 days after filing with the Secretary of State)*

**675 IAC 14-4.3-165 Section G2417.6.2; before turning gas on**

Authority: IC 22-13-2-2; IC 22-13-2-13  
Affected: IC 22-12; IC 22-13; IC 22-14; IC 22-15; IC 36-7



Sec. 165. Change SECTION G2417.6.2 to read as follows: Before gas is introduced into a system of new gas piping, it shall be determined that there are no open fittings or ends and that all manual valves at outlets on equipment are closed and all unused valves at outlets are closed and plugged or capped. *(Fire Prevention and Building Safety Commission; 675 IAC 14-4.3-165; filed Jun 13, 2005, 3:00 p.m.: 28 IR 3292, eff 90 days after filing with the Secretary of State)*

**675 IAC 14-4.3-166 Section G2417.6.3; test for leakage**

Authority: IC 22-13-2-2; IC 22-13-2-13

Affected: IC 22-12; IC 22-13; IC 22-14; IC 22-15; IC 36-7

Sec. 166. (a) Delete, in SECTION G2417.6.3, “or into a system that has been initially restored after an interruption of service,”.

(b) Change the last sentence of SECTION G2417.6.3 to read as follows: If leakage is indicated, the gas supply shall be shut off until the leakage is corrected. *(Fire Prevention and Building Safety Commission; 675 IAC 14-4.3-166; filed Jun 13, 2005, 3:00 p.m.: 28 IR 3292, eff 90 days after filing with the Secretary of State)*

**675 IAC 14-4.3-167 Section G2417.7.1; removal from service**

Authority: IC 22-13-2-2; IC 22-13-2-13

Affected: IC 22-12; IC 22-13; IC 22-14; IC 22-15; IC 36-7

Sec. 167. Delete, from SECTION G2417.7.1, “servicing,” and substitute “an”. *(Fire Prevention and Building Safety Commission; 675 IAC 14-4.3-167; filed Jun 13, 2005, 3:00 p.m.: 28 IR 3292, eff 90 days after filing with the Secretary of State)*

**675 IAC 14-4.3-168 Section G2420.2; meter valve**

Authority: IC 22-13-2-2; IC 22-13-2-13

Affected: IC 22-12; IC 22-13; IC 22-14; IC 22-15; IC 36-7

Sec. 168. Delete SECTION G2420.2. *(Fire Prevention and Building Safety Commission; 675 IAC 14-4.3-168; filed Jun 13, 2005, 3:00 p.m.: 28 IR 3292, eff 90 days after filing with the Secretary of State)*

**675 IAC 14-4.3-169 Section G2423; CNG gas-dispensing systems**

Authority: IC 22-13-2-2; IC 22-13-2-13

Affected: IC 22-12; IC 22-13; IC 22-14; IC 22-15; IC 36-7

Sec. 169. Delete SECTION G2423. *(Fire Prevention and Building Safety Commission; 675 IAC 14-4.3-169; filed Jun 13, 2005, 3:00 p.m.: 28 IR 3292, eff 90 days after filing with the Secretary of State)*

**675 IAC 14-4.3-170 Section G2425.1; scope**

Authority: IC 22-13-2-2; IC 22-13-2-13

Affected: IC 22-12; IC 22-13; IC 22-14; IC 22-15; IC 36-7

Sec. 170. Delete, from SECTION G2425.1, “, maintenance, repair”. *(Fire Prevention and Building Safety Commission; 675 IAC 14-4.3-170; filed Jun 13, 2005, 3:00 p.m.: 28 IR 3292, eff 90 days after filing with the Secretary of State)*

**675 IAC 14-4.3-171 Section G2427.6.10; marking**

Authority: IC 22-13-2-2; IC 22-13-2-13

Affected: IC 22-12; IC 22-13; IC 22-14; IC 22-15; IC 36-7

Sec. 171. Delete SECTION G2427.6.10. *(Fire Prevention and Building Safety Commission; 675 IAC 14-4.3-171; filed Jun 13, 2005, 3:00 p.m.: 28 IR 3293, eff 90 days after filing with the Secretary of State)*

**675 IAC 14-4.3-172 Section G2427.8; venting system termination location**

Authority: IC 22-13-2-2; IC 22-13-2-13

Affected: IC 22-12; IC 22-13; IC 22-14; IC 22-15; IC 36-7

Sec. 172. Change SECTION G2427.8, Item 4, to read as follows: 4. Through-the-wall vents for Categories II and IV appliances and noncategorized appliances shall not terminate over walkways or over an area where condensate or vapor could be detrimental to the operation of regulators, relief valves, or other equipment. *(Fire Prevention and Building Safety Commission; 675 IAC 14-4.3-172; filed Jun 13, 2005, 3:00 p.m.: 28 IR 3293, eff 90 days after filing with the Secretary of State)*

**675 IAC 14-4.3-173 Section G2427.9; condensation drain**

Authority: IC 22-13-2-2; IC 22-13-2-13

Affected: IC 22-12; IC 22-13; IC 22-14; IC 22-15; IC 36-7

Sec. 173. Delete SECTION G2427.9 and substitute to read as follows: For collection and disposal of condensate from venting systems, see local ordinance. *(Fire Prevention and Building Safety Commission; 675 IAC 14-4.3-173; filed Jun 13, 2005, 3:00 p.m.: 28 IR 3293, eff 90 days after filing with the Secretary of State)*

**675 IAC 14-4.3-174 Section G2428.1; definitions**

Authority: IC 22-13-2-2; IC 22-13-2-13

Affected: IC 22-12; IC 22-13; IC 22-14; IC 22-15; IC 36-7

Sec. 174. Add, to the definition of APPLIANCE CATEGORIZED VENT DIAMETER/AREA in SECTION G2428.1, “approved” after “with” and before “nationally”. *(Fire Prevention and Building Safety Commission; 675 IAC 14-4.3-174; filed Jun 13, 2005, 3:00 p.m.: 28 IR 3293, eff 90 days after filing with the Secretary of State)*

**675 IAC 14-4.3-175 Section G2431.1; scope**

Authority: IC 22-13-2-2; IC 22-13-2-13

Affected: IC 22-12; IC 22-13; IC 22-14; IC 22-15; IC 36-7

Sec. 175. Change SECTION G2431.1 to read as follows: This chapter shall govern the approval, design, installation, construction, and alteration of the appliances and equipment specifically identified herein. *(Fire Prevention and Building Safety Commission; 675 IAC 14-4.3-175; filed Jun 13, 2005, 3:00 p.m.: 28 IR 3293, eff 90 days after filing with the Secretary of State)*

**675 IAC 14-4.3-176 Section G2438; clothes dryers**

Authority: IC 22-13-2-2; IC 22-13-2-13

Affected: IC 22-12; IC 22-13; IC 22-14; IC 22-15; IC 36-7

Sec. 176. Delete SECTION G2438. *(Fire Prevention and Building Safety Commission; 675 IAC 14-4.3-176; filed Jun 13, 2005, 3:00 p.m.: 28 IR 3293, eff 90 days after filing with the Secretary of State)*

**675 IAC 14-4.3-177 Section G2439.5.1; maximum length**

Authority: IC 22-13-2-2; IC 22-13-2-13

Affected: IC 22-12; IC 22-13; IC 22-14; IC 22-15; IC 36-7

Sec. 177. Change, in the first sentence of SECTION G2439.5.1, “25 feet (7620 mm)” to read “35 feet”. *(Fire Prevention and Building Safety Commission; 675 IAC 14-4.3-177; filed Jun 13, 2005, 3:00 p.m.: 28 IR 3293, eff 90 days after filing with the Secretary of State)*

**675 IAC 14-4.3-178 Section G2448.1; general**

Authority: IC 22-13-2-2; IC 22-13-2-13

Affected: IC 22-12; IC 22-13-2-9; IC 22-14; IC 22-15; IC 36-7

Sec. 178. Add an exception to the end of SECTION G2448.1 to read as follows: EXCEPTION: Water heaters regulated by the Boiler and Pressure Vessel Rules Board (680 IAC 2) under IC 22-13-2-9 are not regulated by this code. *(Fire Prevention and Building Safety Commission; 675 IAC 14-4.3-178; filed Jun 13, 2005, 3:00 p.m.: 28 IR 3293, eff 90 days after filing with the Secretary of State)*

**675 IAC 14-4.3-179 Section G2452.1; general**

Authority: IC 22-13-2-2; IC 22-13-2-13

Affected: IC 22-12; IC 22-13-2-9; IC 22-14; IC 22-15; IC 36-7

Sec. 179. Add an exception to the end of SECTION G2452.1 to read as follows: EXCEPTION: Boilers regulated by the Boiler and Pressure Vessel Rules Board (680 IAC 2) under IC 22-13-2-9 are not regulated by this code. *(Fire Prevention and Building Safety Commission; 675 IAC 14-4.3-179; filed Jun 13, 2005, 3:00 p.m.: 28 IR 3293, eff 90 days after filing with the Secretary of State)*

**675 IAC 14-4.3-180 Section P2501; general**

Authority: IC 22-13-2-2; IC 22-13-2-13

Affected: IC 22-12; IC 22-13; IC 22-14; IC 22-15; IC 36-7

Sec. 180. Delete SECTION P2501 and substitute to read as follows: The provisions of Chapters 1, 2, and 25 through 32 shall establish the requirements for plumbing and plumbing systems. Compliance with the Indiana Plumbing Code (675 IAC 16) shall be allowed instead of compliance with this code. *(Fire Prevention and Building Safety Commission; 675 IAC 14-4.3-180; filed Jun 13, 2005, 3:00 p.m.: 28 IR 3293, eff 90 days after filing with the Secretary of State)*

**675 IAC 14-4.3-181 Section P2502; existing plumbing systems**

Authority: IC 22-13-2-2; IC 22-13-2-13

Affected: IC 22-12; IC 22-13; IC 22-14; IC 22-15; IC 36-7

Sec. 181. Delete the text of SECTION P2502 and substitute to read as follows: See the General Administrative Rules (675 IAC 12). *(Fire Prevention and Building Safety Commission; 675 IAC 14-4.3-181; filed Jun 13, 2005, 3:00 p.m.: 28 IR 3294, eff 90 days after filing with the Secretary of State)*

**675 IAC 14-4.3-182 Section P2503.1; inspection required**

Authority: IC 22-13-2-2; IC 22-13-2-13

Affected: IC 22-12; IC 22-13; IC 22-14; IC 22-15; IC 36-7

Sec. 182. Delete SECTION P2503.1. *(Fire Prevention and Building Safety Commission; 675 IAC 14-4.3-182; filed Jun 13, 2005, 3:00 p.m.: 28 IR 3294, eff 90 days after filing with the Secretary of State)*

**675 IAC 14-4.3-183 Section P2503.2; concealment**

Authority: IC 22-13-2-2; IC 22-13-2-13

Affected: IC 22-12; IC 22-13; IC 22-14; IC 22-15; IC 36-7

Sec. 183. Delete, in SECTION P2503.2, “, inspected”. *(Fire Prevention and Building Safety Commission; 675 IAC 14-4.3-183; filed Jun 13, 2005, 3:00 p.m.: 28 IR 3294, eff 90 days after filing with the Secretary of State)*

**675 IAC 14-4.3-184 Section P2503.3; responsibility of permitter**

Authority: IC 22-13-2-2; IC 22-13-2-13

Affected: IC 22-12; IC 22-13; IC 22-14; IC 22-15; IC 36-7

Sec. 184. Delete SECTION P2503.3. *(Fire Prevention and Building Safety Commission; 675 IAC 14-4.3-184; filed Jun 13, 2005, 3:00 p.m.: 28 IR 3294, eff 90 days after filing with the Secretary of State)*

**675 IAC 14-4.3-185 Section P2503.5.2; finished plumbing**

Authority: IC 22-13-2-2; IC 22-13-2-13

Affected: IC 22-12; IC 22-13; IC 22-14; IC 22-15; IC 36-7

Sec. 185. Delete, in SECTION P2503.5.2, Item 2, “the local administrative authority” and substitute “local ordinance”. (*Fire Prevention and Building Safety Commission; 675 IAC 14-4.3-185; filed Jun 13, 2005, 3:00 p.m.: 28 IR 3294, eff 90 days after filing with the Secretary of State*)

**675 IAC 14-4.3-186 Section P2503.7; inspection and testing of backflow prevention devices**

Authority: IC 22-13-2-2; IC 22-13-2-13

Affected: IC 22-12; IC 22-13; IC 22-14; IC 22-15; IC 36-7

Sec. 186. Change the title and text of SECTION P2503.7 to read as follows: Testing of backflow prevention devices. Testing of backflow prevention devices shall comply with SECTION P2503.7.2. (*Fire Prevention and Building Safety Commission; 675 IAC 14-4.3-186; filed Jun 13, 2005, 3:00 p.m.: 28 IR 3294, eff 90 days after filing with the Secretary of State*)

**675 IAC 14-4.3-187 Section P2503.7.1; inspections**

Authority: IC 22-13-2-2; IC 22-13-2-13

Affected: IC 22-12; IC 22-13; IC 22-14; IC 22-15; IC 36-7

Sec. 187. Delete SECTION P2503.7.1. (*Fire Prevention and Building Safety Commission; 675 IAC 14-4.3-187; filed Jun 13, 2005, 3:00 p.m.: 28 IR 3294, eff 90 days after filing with the Secretary of State*)

**675 IAC 14-4.3-188 Section P2503.7.2; testing**

Authority: IC 22-13-2-2; IC 22-13-2-13

Affected: IC 22-12; IC 22-13; IC 22-14; IC 22-15; IC 36-7

Sec. 188. Change SECTION P2503.7.2 to read as follows: Reduced pressure principle backflow preventers, double check valve assemblies, double-detector check valve assemblies, and pressure vacuum breaker assemblies shall be tested at the time of installation. (*Fire Prevention and Building Safety Commission; 675 IAC 14-4.3-188; filed Jun 13, 2005, 3:00 p.m.: 28 IR 3294, eff 90 days after filing with the Secretary of State*)

**675 IAC 14-4.3-189 Section P2603.1; general**

Authority: IC 22-13-2-2; IC 22-13-2-13

Affected: IC 22-12; IC 22-13; IC 22-14; IC 22-15; IC 36-7

Sec. 189. Delete, in SECTION P2603.1, “or repairing”. (*Fire Prevention and Building Safety Commission; 675 IAC 14-4.3-189; filed Jun 13, 2005, 3:00 p.m.: 28 IR 3294, eff 90 days after filing with the Secretary of State*)

**675 IAC 14-4.3-190 Section P2603.2.1; protection against physical damage**

Authority: IC 22-13-2-2; IC 22-13-2-13

Affected: IC 22-12; IC 22-13; IC 22-14; IC 22-15; IC 36-7

Sec. 190. Make the following changes in SECTION P2603.2.1: (a) Change “1.5 inches (38 mm)” to read “1¼ inches (31 mm)”. (b) Delete “and shall extend a minimum of 2 inches (51 mm) above sole plates and below top plates”. (*Fire Prevention and Building Safety Commission; 675 IAC 14-4.3-190; filed Jun 13, 2005, 3:00 p.m.: 28 IR 3294, eff 90 days after filing with the Secretary of State*)

**675 IAC 14-4.3-191 Section P2603.5; pipes through footings or foundation walls**

Authority: IC 22-13-2-2; IC 22-13-2-13

Affected: IC 22-12; IC 22-13; IC 22-14; IC 22-15; IC 36-7

Sec. 191. Delete, in SECTION P2603.5, “two pipe sizes”. *(Fire Prevention and Building Safety Commission; 675 IAC 14-4.3-191; filed Jun 13, 2005, 3:00 p.m.: 28 IR 3294, eff 90 days after filing with the Secretary of State)*

**675 IAC 14-4.3-192 Section P2706.2; standpipes**

Authority: IC 22-13-2-2; IC 22-13-2-13  
Affected: IC 22-12; IC 22-13; IC 22-14; IC 22-15; IC 36-7

Sec. 192. Add an exception to the end of SECTION P2706.2 to read as follows: EXCEPTION: A 1½ inch (38 mm) standpipe shall extend a minimum of 30 inches (762 mm) and a maximum of 42 inches (1,067 mm). *(Fire Prevention and Building Safety Commission; 675 IAC 14-4.3-192; filed Jun 13, 2005, 3:00 p.m.: 28 IR 3295, eff 90 days after filing with the Secretary of State)*

**675 IAC 14-4.3-193 Section P2706.2.1; laundry tray connection**

Authority: IC 22-13-2-2; IC 22-13-2-13  
Affected: IC 22-12; IC 22-13; IC 22-14; IC 22-15; IC 36-7

Sec. 193. Delete the last sentence of SECTION P2706.2.1. *(Fire Prevention and Building Safety Commission; 675 IAC 14-4.3-193; filed Jun 13, 2005, 3:00 p.m.: 28 IR 3295, eff 90 days after filing with the Secretary of State)*

**675 IAC 14-4.3-194 Section P2717.3; sink, dishwasher, and food grinder**

Authority: IC 22-13-2-2; IC 22-13-2-13  
Affected: IC 22-12; IC 22-13; IC 22-14; IC 22-15; IC 36-7

Sec. 194. Change the last sentence of P2717.3 to read as follows: The dishwasher waste line shall rise and be securely fastened. *(Fire Prevention and Building Safety Commission; 675 IAC 14-4.3-194; filed Jun 13, 2005, 3:00 p.m.: 28 IR 3295, eff 90 days after filing with the Secretary of State)*

**675 IAC 14-4.3-195 Section P2801.5; required pan**

Authority: IC 22-13-2-2; IC 22-13-2-13  
Affected: IC 22-12; IC 22-13; IC 22-14; IC 22-15; IC 36-7

Sec. 195. (a) In the first sentence of SECTION P2801.5 delete “in locations where leakage of the tanks or connections will cause damage” and insert “above a finished ceiling”.

(b) Add an exception to SECTION P2801.5 to read as follows: EXCEPTION: When installed on a water-resistant floor with a floor drain in the same room or space. *(Fire Prevention and Building Safety Commission; 675 IAC 14-4.3-195; filed Jun 13, 2005, 3:00 p.m.: 28 IR 3295, eff 90 days after filing with the Secretary of State)*

**675 IAC 14-4.3-196 Section P2802.2; temperature control**

Authority: IC 22-13-2-2; IC 22-13-2-13  
Affected: IC 22-12; IC 22-13; IC 22-14; IC 22-15; IC 36-7

Sec. 196. Change, in SECTION P2802.2, “requires” to “allows”. *(Fire Prevention and Building Safety Commission; 675 IAC 14-4.3-196; filed Jun 13, 2005, 3:00 p.m.: 28 IR 3295, eff 90 days after filing with the Secretary of State)*

**675 IAC 14-4.3-197 Section P2901.1; potable water required**

Authority: IC 22-13-2-2; IC 22-13-2-13  
Affected: IC 22-12; IC 22-13; IC 22-14; IC 22-15; IC 36-7

Sec. 197. Change, in SECTION P2901.1, “appropriate” to “approved”. *(Fire Prevention and Building Safety Commission; 675 IAC 14-4.3-197; filed Jun 13, 2005, 3:00 p.m.: 28 IR 3295, eff 90 days after filing with the Secretary of State)*

**675 IAC 14-4.3-198 Section P2903.5; water hammer**

Authority: IC 22-13-2-2; IC 22-13-2-13

Affected: IC 22-12; IC 22-13; IC 22-14; IC 22-15; IC 36-7

Sec. 198. Change SECTION P2903.5 to read as follows: Water Hammer. The flow velocity through the water distribution system shall be controlled to reduce the possibility of water hammer. Water hammer arrestors, when installed, shall be installed in accordance with manufacturer's installation instructions and shall conform to ASSE/ANSI 1010. *(Fire Prevention and Building Safety Commission; 675 IAC 14-4.3-198; filed Jun 13, 2005, 3:00 p.m.: 28 IR 3295, eff 90 days after filing with the Secretary of State)*

**675 IAC 14-4.3-199 Section P2903.9.1; service valve**

Authority: IC 22-13-2-2; IC 22-13-2-13

Affected: IC 22-12; IC 22-13; IC 22-14; IC 22-15; IC 36-7

Sec. 199. Change, in the last sentence of SECTION P2903.9.1, "requirements" to "ordinance". *(Fire Prevention and Building Safety Commission; 675 IAC 14-4.3-199; filed Jun 13, 2005, 3:00 p.m.: 28 IR 3295, eff 90 days after filing with the Secretary of State)*

**675 IAC 14-4.3-200 Section P3007.1; sewage ejectors or sewage pumps**

Authority: IC 22-13-2-2; IC 22-13-2-13

Affected: IC 22-12; IC 22-13; IC 22-14; IC 22-15; IC 36-7

Sec. 200. Delete the fourth sentence of SECTION 3007.1 and substitute to read as follows: A check valve, and a full way valve located on the discharge side of the check valve, shall be installed in the pump or ejector discharge piping between the pump or ejector and the drainage system. *(Fire Prevention and Building Safety Commission; 675 IAC 14-4.3-200; filed Jun 13, 2005, 3:00 p.m.: 28 IR 3295, eff 90 days after filing with the Secretary of State)*

**675 IAC 14-4.3-201 Section P3007.1.1; ejectors alarms**

Authority: IC 22-13-2-2; IC 22-13-2-13

Affected: IC 22-12; IC 22-13; IC 22-14; IC 22-15; IC 36-7

Sec. 201. Add SECTION 3007.1.1 to read as follows: Sewage ejectors that discharge by means of automatic pumping equipment shall be provided with an approved, electrically operated high water indicating alarm. A remote sensor shall activate the alarm when the fluid level exceeds a preset level that is less than the maximum capacity of the pit. The alarm shall function to provide a signal to occupants within the dwelling. Electrical power for the alarm shall be supplied through a branch circuit separate from that supplying the pump motor. *(Fire Prevention and Building Safety Commission; 675 IAC 14-4.3-201; filed Jun 13, 2005, 3:00 p.m.: 28 IR 3295, eff 90 days after filing with the Secretary of State)*

**675 IAC 14-4.3-202 Section P3101.4; extension outside a structure**

Authority: IC 22-13-2-2; IC 22-13-2-13

Affected: IC 22-12; IC 22-13; IC 22-14; IC 22-15; IC 36-7

Sec. 202. Delete SECTION P3101.4. *(Fire Prevention and Building Safety Commission; 675 IAC 14-4.3-202; filed Jun 13, 2005, 3:00 p.m.: 28 IR 3296, eff 90 days after filing with the Secretary of State)*

**675 IAC 14-4.3-203 Section P3101.5; flood resistance**

Authority: IC 22-13-2-2; IC 22-13-2-13

Affected: IC 22-12; IC 22-13; IC 22-14; IC 22-15; IC 36-7

Sec. 203. Delete SECTION P3101.5. *(Fire Prevention and Building Safety Commission; 675 IAC 14-4.3-203; filed Jun 13, 2005, 3:00 p.m.: 28 IR 3296, eff 90 days after filing with the Secretary of State)*

**675 IAC 14-4.3-204 Section P3103.1; roof extension**

Authority: IC 22-13-2-2; IC 22-13-2-13

Affected: IC 22-12; IC 22-13; IC 22-14; IC 22-15; IC 36-7

Sec. 204. Change SECTION P3103.1 to read as follows: All open pipes that extend through a roof shall be terminated at least 12 inches (305 mm) above the highest point where the vent passes through the roof except that where a roof is to be used for any purpose other than weather protection, the vent extension shall terminate no less than 7 feet (2,134 mm) above the roof. *(Fire Prevention and Building Safety Commission; 675 IAC 14-4.3-204; filed Jun 13, 2005, 3:00 p.m.: 28 IR 3296, eff 90 days after filing with the Secretary of State)*

**675 IAC 14-4.3-205 Section P3103.2; frost closure**

Authority: IC 22-13-2-2; IC 22-13-2-13

Affected: IC 22-12; IC 22-13; IC 22-14; IC 22-15; IC 36-7

Sec. 205. Delete SECTION P3103.2. *(Fire Prevention and Building Safety Commission; 675 IAC 14-4.3-205; filed Jun 13, 2005, 3:00 p.m.: 28 IR 3296, eff 90 days after filing with the Secretary of State)*

**675 IAC 14-4.3-206 Table P3105.1; maximum distance of fixture trap from vent**

Authority: IC 22-13-2-2; IC 22-13-2-13

Affected: IC 22-12; IC 22-13; IC 22-14; IC 22-15; IC 36-7

Sec. 206. Add a note to TABLE P3105.1 to read as follows: NOTE: A trap arm serving only a bath tub or shower may be increased to 9 feet with a slope of not less than 1/8 inch per foot. *(Fire Prevention and Building Safety Commission; 675 IAC 14-4.3-206; filed Jun 13, 2005, 3:00 p.m.: 28 IR 3296, eff 90 days after filing with the Secretary of State)*

**675 IAC 14-4.3-207 Table P3201.4; building traps**

Authority: IC 22-13-2-2; IC 22-13-2-13

Affected: IC 22-12; IC 22-13; IC 22-14; IC 22-15; IC 36-7

Sec. 207. Change SECTION P3201.4 as follows: Insert a “.” after “installed” and delete the remainder of the paragraph. *(Fire Prevention and Building Safety Commission; 675 IAC 14-4.3-207; filed Jun 13, 2005, 3:00 p.m.: 28 IR 3296, eff 90 days after filing with the Secretary of State)*

**675 IAC 14-4.3-208 Table P3201.7; size of traps and trap arms for plumbing fixtures**

Authority: IC 22-13-2-2; IC 22-13-2-13

Affected: IC 22-12; IC 22-13; IC 22-14; IC 22-15; IC 36-7

Sec. 208. Change TABLE P3201.7 as follows: (a) Change the shower trap size minimum from “2” to “1½”.

(b) Add note (b) to read as follows: (b) A clothes washer standpipe may be 1½ inches when installed in accordance with SECTION P2706.2. *(Fire Prevention and Building Safety Commission; 675 IAC 14-4.3-208; filed Jun 13, 2005, 3:00 p.m.: 28 IR 3296, eff 90 days after filing with the Secretary of State)*

**675 IAC 14-4.3-209 Section E3301.2; scope**

Authority: IC 22-13-2-2; IC 22-13-2-13

Affected: IC 22-12; IC 22-13; IC 22-14; IC 22-15; IC 36-7

Sec. 209. Change SECTION E3301.2 to read as follows: Chapters 1 and 33 through 42 shall cover the installation of electrical systems, equipment, and components for the permanent heating, ventilating, air conditioning, electrical, plumbing, sanitary, emergency detection, emergency communication, or fire or explosion suppression systems that are part of a Class 1 structure-townhouse or Class 2 structure-one and two family dwelling.

Services within the scope of this code shall be limited to 120/240-volt, 0 to 400 ampere, single-phase systems.

The omission from these chapters of any material or method of construction provided for in the Indiana Electrical Code (675 IAC 17) shall not be construed as prohibiting the use of such material or method of construction. Electrical systems, equipment, or components not specifically addressed in these chapters shall comply with the applicable provisions of the Indiana Electrical Code (675 IAC 17).

Compliance with the Indiana Electrical Code (675 IAC 17) is allowed instead of compliance with this code.

EXCEPTION: This section does not require the installation of an electrical system in Class 2 structures.

*(Fire Prevention and Building Safety Commission; 675 IAC 14-4.3-209; filed Jun 13, 2005, 3:00 p.m.: 28 IR 3296, eff 90 days after filing with the Secretary of State)*

**675 IAC 14-4.3-210 Section E3301.3; not covered**

Authority: IC 22-13-2-2; IC 22-13-2-13

Affected: IC 22-12; IC 22-13; IC 22-14; IC 22-15; IC 36-7

Sec. 210. Add Item 3 to SECTION E3301.3 to read as follows: 3. Installations not part of a Class 1 structure-townhouse or Class 2 structure-one and two family dwelling. *(Fire Prevention and Building Safety Commission; 675 IAC 14-4.3-210; filed Jun 13, 2005, 3:00 p.m.: 28 IR 3297, eff 90 days after filing with the Secretary of State)*

**675 IAC 14-4.3-211 Section E3303.2; inspection required**

Authority: IC 22-13-2-2; IC 22-13-2-13

Affected: IC 22-12; IC 22-13; IC 22-14; IC 22-15; IC 36-7

Sec. 211. Delete SECTION E3303.2. *(Fire Prevention and Building Safety Commission; 675 IAC 14-4.3-211; filed Jun 13, 2005, 3:00 p.m.: 28 IR 3297, eff 90 days after filing with the Secretary of State)*

**675 IAC 14-4.3-212 Section E3304.2; interrupting rating**

Authority: IC 22-13-2-2; IC 22-13-2-13

Affected: IC 22-12; IC 22-13; IC 22-14; IC 22-15; IC 36-7

Sec. 212. Change SECTION E3304.2 to read as follows: Equipment intended to interrupt current at fault levels shall have an interrupting rating sufficient for the nominal circuit voltage and the current that is available at the line terminals of the equipment. Equipment intended to interrupt current at other than fault levels shall have an interrupting rating at nominal circuit voltage sufficient for the current that must be interrupted. *(Fire Prevention and Building Safety Commission; 675 IAC 14-4.3-212; filed Jun 13, 2005, 3:00 p.m.: 28 IR 3297, eff 90 days after filing with the Secretary of State)*

**675 IAC 14-4.3-213 Section E3305.6; illumination**

Authority: IC 22-13-2-2; IC 22-13-2-13

Affected: IC 22-12; IC 22-13; IC 22-14; IC 22-15; IC 36-7

Sec. 213. Add a sentence to the end of SECTION E3305.6 to read as follows: Additional lighting outlets shall not be required where the work space is illuminated by an adjacent artificial light source. *(Fire Prevention and Building Safety Commission; 675 IAC 14-4.3-213; filed Jun 13, 2005, 3:00 p.m.: 28 IR 3297, eff 90 days after filing with the Secretary of State; filed Oct 21, 2005, 1:50 p.m.: 29 IR 806)*

**675 IAC 14-4.3-214 Section E3306.5; individual conductor insulation (Repealed)**

Sec. 214. *(Repealed by Fire Prevention and Building Safety Commission; filed Oct 21, 2005, 1:50 p.m.: 29 IR 815)*

**675 IAC 14-4.3-214.5 Section E3307.1; grounded conductors**

Authority: IC 22-13-2-2; IC 22-13-2-13

Affected: IC 22-12; IC 22-13; IC 22-14; IC 22-15; IC 36-7



Sec. 214.5. In the second sentence of SECTION E3307.1, after “distinctive white”, add “or gray”. (*Fire Prevention and Building Safety Commission; 675 IAC 14-4.3-214.5; filed Oct 21, 2005, 1:50 p.m.: 29 IR 807*)

**675 IAC 14-4.3-215 Section E3401; general**

Authority: IC 22-13-2-2; IC 22-13-2-13

Affected: IC 22-12; IC 22-13; IC 22-14; IC 22-15; IC 36-7

Sec. 215. Change SECTION E3401 as follows: (a) Delete the definition of APPROVED and substitute to read as follows: See the definition of APPROVED in SECTION R202.

(b) Delete the definition of BRANCH CIRCUIT, GENERAL PURPOSE and substitute: A branch circuit that supplies two or more receptacles or outlets for lighting and appliances.

(c) Change the definition of Grounding Conductor, Equipment to read as follows: The conductor used to connect the noncurrent-carrying metal parts of equipment, raceways, and other enclosures to the system grounded conductor or the grounding electrode conductor, or both, at the service equipment or at the source of a separately derived system.

(d) Change the definition of Grounding Electrode Conductor to read as follows: The conductor used to connect the grounding electrode(s) to the equipment grounded conductor or to the grounded conductor, or to both, at the service equipment, at each building or structure where supplied from a common service, or at the source of a separately derived system.

(e) Delete the definition of LABELED and substitute as follows: See the definition of LABELED in SECTION R202.

(f) Delete the definition of LISTED and substitute to read as follows: See the definition of LISTED AND LISTING in SECTION R202. (*Fire Prevention and Building Safety Commission; 675 IAC 14-4.3-215; filed Jun 13, 2005, 3:00 p.m.: 28 IR 3297, eff 90 days after filing with the Secretary of State; filed Oct 21, 2005, 1:50 p.m.: 29 IR 807*)

**675 IAC 14-4.3-216 Section E3501.6.2; service disconnect location**

Authority: IC 22-13-2-2; IC 22-13-2-13

Affected: IC 22-12; IC 22-13; IC 22-14; IC 22-15; IC 36-7

Sec. 216. At the end of SECTION E3501.6.2, add a sentence to read as follows: Conductors shall be considered outside of a building or structure under any of the following conditions:

(1) where installed under not less than 2 inches (51 mm) of concrete beneath a building or other structure,

(2) where installed within a building or other structure in a raceway that is encased in concrete or brick not less than 2 inches thick, or

(3) where installed in conduit and under not less than 18 inches (457 mm) of earth beneath a building or other structure.

(*Fire Prevention and Building Safety Commission; 675 IAC 14-4.3-216; filed Jun 13, 2005, 3:00 p.m.: 28 IR 3297, eff 90 days after filing with the Secretary of State; filed Oct 21, 2005, 1:50 p.m.: 29 IR 807*)

**675 IAC 14-4.3-217 Table E3503.1; service conductor and grounding electrode conductor sizing (Repealed)**

Sec. 217. (*Repealed by Fire Prevention and Building Safety Commission; filed Oct 21, 2005, 1:50 p.m.: 29 IR 815*)

**675 IAC 14-4.3-218 Section E3504.2.1; above roofs**

Authority: IC 22-13-2-2; IC 22-13-2-13

Affected: IC 22-12; IC 22-13; IC 22-14; IC 22-15; IC 36-7

Sec. 218. In Exception 1, after “pedestrian”, insert “or vehicular”. (*Fire Prevention and Building Safety Commission; 675 IAC 14-4.3-218; filed Jun 13, 2005, 3:00 p.m.: 28 IR 3298, eff 90 days after filing with the Secretary of State*)

**675 IAC 14-4.3-219 Section E3505.5; protection of service cables against damage**

Authority: IC 22-13-2-2; IC 22-13-2-13

Affected: IC 22-12; IC 22-13; IC 22-14; IC 22-15; IC 36-7

Sec. 219. In SECTION E3505.5, delete “rigid nonmetallic conduit suitable for the location” and insert “Schedule 80 rigid

nonmetallic conduit”. (*Fire Prevention and Building Safety Commission; 675 IAC 14-4.3-219; filed Jun 13, 2005, 3:00 p.m.: 28 IR 3298, eff 90 days after filing with the Secretary of State*)

**675 IAC 14-4.3-220 Section E3506.3; available short-circuit current**

Authority: IC 22-13-2-2; IC 22-13-2-13

Affected: IC 22-12; IC 22-13; IC 22-14; IC 22-15; IC 36-7

Sec. 220. Delete, from SECTION E3506.3, “, but not less than 10,000 amperes”. (*Fire Prevention and Building Safety Commission; 675 IAC 14-4.3-220; filed Jun 13, 2005, 3:00 p.m.: 28 IR 3298, eff 90 days after filing with the Secretary of State*)

**675 IAC 14-4.3-220.3 Section E3508.1; grounding electrode system**

Authority: IC 22-13-2-2; IC 22-13-2-13

Affected: IC 22-12; IC 22-13; IC 22-14; IC 22-15; IC 36-7

Sec. 220.3. (a) In the first sentence of SECTION E3508.1, delete “available” and insert “present”.

(b) After the text of SECTION E3508.1, add an exception to read as follows: Exception: Concrete-encased electrodes of existing buildings or structures shall not be required to be part of the grounding electrode system where the steel reinforcing bars or rods are not accessible for use without disturbing the concrete. (*Fire Prevention and Building Safety Commission; 675 IAC 14-4.3-220.3; filed Oct 21, 2005, 1:50 p.m.: 29 IR 807*)

**675 IAC 14-4.3-220.6 Section E3509.7; bonding other metal piping**

Authority: IC 22-13-2-2; IC 22-13-2-13

Affected: IC 22-12; IC 22-13; IC 22-14; IC 22-15; IC 36-7

Sec. 220.6. Before the period following the next to last sentence in SECTION E3509.7, add “if connected using a fixed wiring method”. (*Fire Prevention and Building Safety Commission; 675 IAC 14-4.3-220.6; filed Oct 21, 2005, 1:50 p.m.: 29 IR 807*)

**675 IAC 14-4.3-220.7 Section E3510.1; installation**

Authority: IC 22-13-2-2; IC 22-13-2-13

Affected: IC 22-12; IC 22-13; IC 22-14; IC 22-15; IC 36-7

Sec. 220.7. Change SECTION E3510.1 as follows: (a) In the second sentence of SECTION E3510.1, delete “severe”.

(b) In the third sentence of SECTION E3510.1, after “grounding”, add “electrode”.

(c) In the third sentence of SECTION E3510.1, delete “and”.

(d) In the third sentence of SECTION E3510.1, before “rigid nonmetallic conduit”, add “Schedule 80”.

(e) In the fourth sentence of SECTION E3510.1, after “grounding”, add “electrode”.

(f) In the fourth sentence of SECTION E3510.1, before “rigid nonmetallic conduit”, add “Schedule 80”.

(g) In the first sentence of the second paragraph of SECTION E3510.1, delete “Insulated or bare” and insert “Bare”. (*Fire Prevention and Building Safety Commission; 675 IAC 14-4.3-220.7; filed Oct 21, 2005, 1:50 p.m.: 29 IR 808*)

**675 IAC 14-4.3-220.8 Section E3510.2; enclosures for grounding electrode conductors**

Authority: IC 22-13-2-2; IC 22-13-2-13

Affected: IC 22-12; IC 22-13; IC 22-14; IC 22-15; IC 36-7

Sec. 220.8. (a) In the first and second sentences of SECTION E3510.2, delete “Metal” and insert “Ferrous metal”.

(b) In the second and third sentences of SECTION E3510.2, insert “electrode” between “grounding” and “conductor”. (*Fire Prevention and Building Safety Commission; 675 IAC 14-4.3-220.8; filed Oct 21, 2005, 1:50 p.m.: 29 IR 808*)

**675 IAC 14-4.3-221 Section E3511.1; methods of grounding conductor connection to electrodes**

Authority: IC 22-13-2-2; IC 22-13-2-13

Affected: IC 22-12; IC 22-13; IC 22-14; IC 22-15; IC 36-7

Sec. 221. Change the first sentence of SECTION E3511.1 by adding “exothermic welding” between “by” and “listed”. (*Fire Prevention and Building Safety Commission; 675 IAC 14-4.3-221; filed Jun 13, 2005, 3:00 p.m.: 28 IR 3298, eff 90 days after filing with the Secretary of State*)

**675 IAC 14-4.3-222 Section E3602.9.1; minimum branch circuit for ranges**

Authority: IC 22-13-2-2; IC 22-13-2-13

Affected: IC 22-12; IC 22-13; IC 22-14; IC 22-15; IC 36-7

Sec. 222. Add Exceptions 1 and 2 to SECTION E3602.9.1 to read as follows:

EXCEPTIONS: 1. Tap conductors supplying electric ranges, wall-mounted electric ovens, and counter-mounted electric cooking units from a 50-ampere branch circuit shall have an ampacity of not less than 20 and shall be sufficient for the load to be served. The taps shall not be longer than necessary for servicing the appliance.

2. The neutral conductor of a 3-wire branch circuit supplying a household electric range, a wall-mounted oven, or a counter-mounted cooking unit shall be permitted to be smaller than the ungrounded conductors where the maximum demand of a range of 8¾ kW or more rating has been computed according to Column A of TABLE E3604.3(2), but shall have an ampacity of not less than 70 percent of the branch-circuit rating and shall not be smaller than No. 10.

(*Fire Prevention and Building Safety Commission; 675 IAC 14-4.3-222; filed Jun 13, 2005, 3:00 p.m.: 28 IR 3298, eff 90 days after filing with the Secretary of State*)

**675 IAC 14-4.3-223 Section E3602.10; branch circuits serving heating loads**

Authority: IC 22-13-2-2; IC 22-13-2-13

Affected: IC 22-12; IC 22-13; IC 22-14; IC 22-15; IC 36-7

Sec. 223. In the second sentence of SECTION E3602.10, insert “25” to the list of circuit ratings. (*Fire Prevention and Building Safety Commission; 675 IAC 14-4.3-223; filed Jun 13, 2005, 3:00 p.m.: 28 IR 3298, eff 90 days after filing with the Secretary of State*)

**675 IAC 14-4.3-224 Section E3602.12; branch circuits serving room air conditioners**

Authority: IC 22-13-2-2; IC 22-13-2-13

Affected: IC 22-12; IC 22-13; IC 22-14; IC 22-15; IC 36-7

Sec. 224. In SECTION E3602.12, Item 4, delete “or the rating of the branch-circuit conductors”. (*Fire Prevention and Building Safety Commission; 675 IAC 14-4.3-224; filed Jun 13, 2005, 3:00 p.m.: 28 IR 3298, eff 90 days after filing with the Secretary of State*)

**675 IAC 14-4.3-225 Section E3602.12.1; where no other loads are supplied**

Authority: IC 22-13-2-2; IC 22-13-2-13

Affected: IC 22-12; IC 22-13; IC 22-14; IC 22-15; IC 36-7

Sec. 225. In SECTION E3602.12.1, delete “appliances are also supplied” and insert “loads are supplied”. (*Fire Prevention and Building Safety Commission; 675 IAC 14-4.3-225; filed Jun 13, 2005, 3:00 p.m.: 28 IR 3299, eff 90 days after filing with the Secretary of State*)

**675 IAC 14-4.3-226 Section E3602.12.2; where lighting units or other appliances are also supplied**

Authority: IC 22-13-2-2; IC 22-13-2-13

Affected: IC 22-12; IC 22-13; IC 22-14; IC 22-15; IC 36-7

Sec. 226. Delete the text of SECTION E3602.12.2 and substitute: The total marked rating of a cord-and-attachment-plug-connected room air conditioner shall not exceed 50 percent of the rating of a branch circuit where lighting outlets, other appliances, or general use receptacles are also supplied. Where the circuitry is interlocked to prevent simultaneous operation of the room air conditioner and energization of other outlets on the same branch circuit, a cord-and-attachment-plug-connected room air conditioner

shall not exceed 80 percent of the branch-circuit rating. *(Fire Prevention and Building Safety Commission; 675 IAC 14-4.3-226; filed Jun 13, 2005, 3:00 p.m.: 28 IR 3299, eff 90 days after filing with the Secretary of State)*

**675 IAC 14-4.3-226.2 Section E3603.1; branch circuits for heating**

Authority: IC 22-13-2-2; IC 22-13-2-13

Affected: IC 22-12; IC 22-13; IC 22-14; IC 22-15; IC 36-7

Sec. 226.2. Add an exception to the end of SECTION E3603.1 to read as follows: Exception: Permanently connected air-conditioning equipment shall be permitted to be connected to the same branch circuit. *(Fire Prevention and Building Safety Commission; 675 IAC 14-4.3-226.2; filed Oct 21, 2005, 1:50 p.m.: 29 IR 808)*

**675 IAC 14-4.3-227 Section E3604.4; feeder neutral load**

Authority: IC 22-13-2-2; IC 22-13-2-13

Affected: IC 22-12; IC 22-13; IC 22-14; IC 22-15; IC 36-7

Sec. 227. Add a sentence to the end of SECTION 3604.4 to read as follows: "A further demand factor of 70 percent shall be permitted for that portion of the unbalanced load in excess of 200 amps." *(Fire Prevention and Building Safety Commission; 675 IAC 14-4.3-227; filed Jun 13, 2005, 3:00 p.m.: 28 IR 3299, eff 90 days after filing with the Secretary of State)*

**675 IAC 14-4.3-227.1 Table E3701.4; allowable applications for wiring methods**

Authority: IC 22-13-2-2; IC 22-13-2-13

Affected: IC 22-12; IC 22-13; IC 22-14; IC 22-15; IC 36-7

Sec. 227.1. In the third column, in the sixteenth line of TABLE E3701.4, delete "--" and insert "A". *(Fire Prevention and Building Safety Commission; 675 IAC 14-4.3-227.1; filed Oct 21, 2005, 1:50 p.m.: 29 IR 808)*

**675 IAC 14-4.3-227.5 Section E3702.4; in unfinished basements**

Authority: IC 22-13-2-2; IC 22-13-2-13

Affected: IC 22-12; IC 22-13; IC 22-14; IC 22-15; IC 36-7

Sec. 227.5. At the end of SECTION E3702.4, add the following: NM cable used on a wall of an unfinished basement shall be installed in a listed conduit or tubing. Conduit or tubing shall utilize a nonmetallic bushing or adapter at the point the cable enters the raceway. Metal conduit and tubings and metal outlet boxes shall be grounded. *(Fire Prevention and Building Safety Commission; 675 IAC 14-4.3-227.5; filed Oct 21, 2005, 1:50 p.m.: 29 IR 808)*

**675 IAC 14-4.3-227.6 Section E3703.3; grounding**

Authority: IC 22-13-2-2; IC 22-13-2-13

Affected: IC 22-12; IC 22-13; IC 22-14; IC 22-15; IC 36-7

Sec. 227.6. Delete SECTION E3703.3 without substitution. *(Fire Prevention and Building Safety Commission; 675 IAC 14-4.3-227.6; filed Oct 21, 2005, 1:50 p.m.: 29 IR 808)*

**675 IAC 14-4.3-228 Section E3703.4; protection from damage**

Authority: IC 22-13-2-2; IC 22-13-2-13

Affected: IC 22-12; IC 22-13; IC 22-14; IC 22-15; IC 36-7

Sec. 228. Delete the third sentence of SECTION E3703.4 without substitution. *(Fire Prevention and Building Safety Commission; 675 IAC 14-4.3-228; filed Jun 13, 2005, 3:00 p.m.: 28 IR 3299, eff 90 days after filing with the Secretary of State; filed Oct 21, 2005, 1:50 p.m.: 29 IR 808)*

**675 IAC 14-4.3-229 Figure E3801.4; countertop receptacles**

Authority: IC 22-13-2-2; IC 22-13-2-13

Affected: IC 22-12; IC 22-13; IC 22-14; IC 22-15; IC 36-7

Sec. 229. Change FIGURE E3801.4 as follows: Add to FIGURE E3801.4 text to read “GFCI” next to the receptacle for the island countertop. (*Fire Prevention and Building Safety Commission; 675 IAC 14-4.3-229; filed Jun 13, 2005, 3:00 p.m.: 28 IR 3299, eff 90 days after filing with the Secretary of State*)

**675 IAC 14-4.3-229.5 Section E3801.4.1; wall counter space**

Authority: IC 22-13-2-2; IC 22-13-2-13

Affected: IC 22-12; IC 22-13; IC 22-14; IC 22-15; IC 36-7

Sec. 229.5. (a) After SECTION E3801.4.1, add an exception to read as follows: Exception: Receptacle outlets shall not be required on a wall directly behind a range or sink in the installation described in FIGURE E3801.4.1.

(b) After SECTION E3801.4.1, add FIGURE E3801.4.1 as follows:

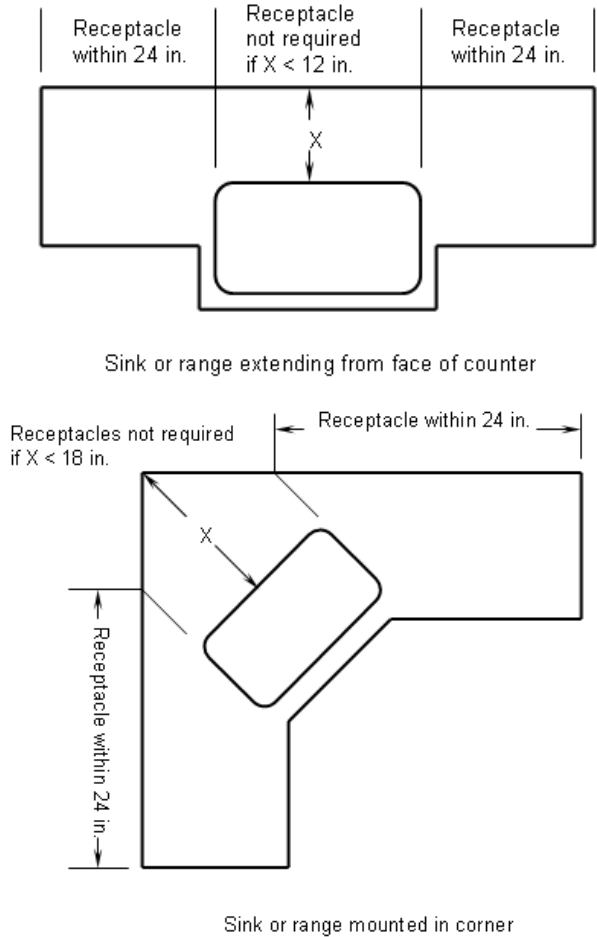

**FIGURE E3801.4.1**

(*Fire Prevention and Building Safety Commission; 675 IAC 14-4.3-229.5; filed Oct 21, 2005, 1:50 p.m.: 29 IR 809*)

**675 IAC 14-4.3-230 Section E3801.4.5; receptacle outlet location**

Authority: IC 22-13-2-2; IC 22-13-2-13

Affected: IC 22-12; IC 22-13; IC 22-14; IC 22-15; IC 36-7

Sec. 230. Change the first sentence of SECTION E3801.4.5 to read as follows: Receptacle outlets shall be located above, but not more than 20 inches (508 mm) above the countertop. (*Fire Prevention and Building Safety Commission; 675 IAC 14-4.3-230; filed Jun 13, 2005, 3:00 p.m.: 28 IR 3299, eff 90 days after filing with the Secretary of State*)

**675 IAC 14-4.3-231 Section E3801.6; bathroom**

Authority: IC 22-13-2-2; IC 22-13-2-13

Affected: IC 22-12; IC 22-13; IC 22-14; IC 22-15; IC 36-7

Sec. 231. (a) In SECTION E3801.6, delete the second sentence and substitute: The receptacle outlet shall be located on a wall or partition that is adjacent to the basin or basin countertop.

(b) Add an exception to SECTION E3801.6 to read as follows: Exception: The receptacle shall not be required to be mounted in the wall or partition where it is installed on the side or face of the basin cabinet not more than 12 inches below the countertop. (*Fire Prevention and Building Safety Commission; 675 IAC 14-4.3-231; filed Jun 13, 2005, 3:00 p.m.: 28 IR 3299, eff 90 days after filing with the Secretary of State; filed Oct 21, 2005, 1:50 p.m.: 29 IR 809*)

**675 IAC 14-4.3-232 Section E3801.9; basements and garages**

Authority: IC 22-13-2-2; IC 22-13-2-13

Affected: IC 22-12; IC 22-13; IC 22-14; IC 22-15; IC 36-7

Sec. 232. In the last sentence of SECTION E3801.9, delete “in the unfinished portion” and substitute “in each separate unfinished portion”. (*Fire Prevention and Building Safety Commission; 675 IAC 14-4.3-232; filed Jun 13, 2005, 3:00 p.m.: 28 IR 3299, eff 90 days after filing with the Secretary of State*)

**675 IAC 14-4.3-233 Section E3801.11; HVAC outlet**

Authority: IC 22-13-2-2; IC 22-13-2-13

Affected: IC 22-12; IC 22-13; IC 22-14; IC 22-15; IC 36-7

Sec. 233. In the last sentence of SECTION E3801.11, delete “and shall be protected in accordance with SECTION E3802.4” without substitution. (*Fire Prevention and Building Safety Commission; 675 IAC 14-4.3-233; filed Jun 13, 2005, 3:00 p.m.: 28 IR 3299, eff 90 days after filing with the Secretary of State; filed Oct 21, 2005, 1:50 p.m.: 29 IR 809*)

**675 IAC 14-4.3-233.5 Section E3802.7; bar sink receptacles**

Authority: IC 22-13-2-2; IC 22-13-2-13

Affected: IC 22-12; IC 22-13; IC 22-14; IC 22-15; IC 36-7

Sec. 233.5. (a) In the title of SECTION E3802.7, before “bar sink receptacles”, insert “laundry, utility, and wet”.

(b) Change the first sentence of SECTION E3802.7 to read as follows: All 125-volt, single-phase, 15- and 20-ampere receptacles that are installed within 6 feet of the outside edge of a laundry, utility, or wet bar sink shall have ground-fault circuit-interrupter protection for personnel. (*Fire Prevention and Building Safety Commission; 675 IAC 14-4.3-233.5; filed Oct 21, 2005, 1:50 p.m.: 29 IR 809*)

**675 IAC 14-4.3-234 Section E3802.8; boathouse receptacles**

Authority: IC 22-13-2-2; IC 22-13-2-13

Affected: IC 22-12; IC 22-13; IC 22-14; IC 22-15; IC 36-7

Sec. 234. Change SECTION 3802.8 to read as follows: All 125-volt, single phase, 15- or 20-ampere receptacles and outlets that supply boat hoists installed in boathouses shall have ground-fault circuit-interrupter protection for personnel. (*Fire Prevention*

*and Building Safety Commission; 675 IAC 14-4.3-234; filed Jun 13, 2005, 3:00 p.m.: 28 IR 3299, eff 90 days after filing with the Secretary of State; filed Oct 21, 2005, 1:50 p.m.: 29 IR 810)*

**675 IAC 14-4.3-235 Section E3802.11; bedroom outlets**

Authority: IC 22-13-2-2; IC 22-13-2-13

Affected: IC 22-12; IC 22-13; IC 22-14; IC 22-15; IC 36-7

Sec. 235. Delete SECTION E3802.11. (*Fire Prevention and Building Safety Commission; 675 IAC 14-4.3-235; filed Jun 13, 2005, 3:00 p.m.: 28 IR 3300, eff 90 days after filing with the Secretary of State; filed Oct 21, 2005, 1:50 p.m.: 29 IR 810)*)

**675 IAC 14-4.3-236 Section E3803.3; additional locations**

Authority: IC 22-13-2-2; IC 22-13-2-13

Affected: IC 22-12; IC 22-13; IC 22-14; IC 22-15; IC 36-7

Sec. 236. In the second sentence, the third sentence, and the exception of SECTION E3803.3, delete “egress door” and substitute “entrances or exits”. (*Fire Prevention and Building Safety Commission; 675 IAC 14-4.3-236; filed Jun 13, 2005, 3:00 p.m.: 28 IR 3300, eff 90 days after filing with the Secretary of State)*)

**675 IAC 14-4.3-237 Section E3805.1; box, conduit body, or fitting; where required**

Authority: IC 22-13-2-2; IC 22-13-2-13

Affected: IC 22-12; IC 22-13; IC 22-14; IC 22-15; IC 36-7

Sec. 237. In the first sentence of SECTION E3805.1, after “junction point”, insert “, termination point”. (*Fire Prevention and Building Safety Commission; 675 IAC 14-4.3-237; filed Jun 13, 2005, 3:00 p.m.: 28 IR 3300, eff 90 days after filing with the Secretary of State)*)

**675 IAC 14-4.3-238 Section E3805.3.1; nonmetallic-sheathed cable and nonmetallic boxes**

Authority: IC 22-13-2-2; IC 22-13-2-13

Affected: IC 22-12; IC 22-13; IC 22-14; IC 22-15; IC 36-7

Sec. 238. In SECTION E3805.3.1, after “Where nonmetallic-sheathed cable”, insert “or multiconductor Type UF cable” and, after “¼ inch (6.4 mm)”, insert “and beyond any cable clamp”. (*Fire Prevention and Building Safety Commission; 675 IAC 14-4.3-238; filed Jun 13, 2005, 3:00 p.m.: 28 IR 3300, eff 90 days after filing with the Secretary of State)*)

**675 IAC 14-4.3-239 Section E3805.3.2; securing to box**

Authority: IC 22-13-2-2; IC 22-13-2-13

Affected: IC 22-12; IC 22-13; IC 22-14; IC 22-15; IC 36-7

Sec. 239. In SECTION E3805.3.2, in the exception, after “Where nonmetallic-sheathed”, insert “or multiconductor Type UF” and, at the end of the exception, insert “Multiple cable entries shall be permitted in a single cable knockout opening”. (*Fire Prevention and Building Safety Commission; 675 IAC 14-4.3-239; filed Jun 13, 2005, 3:00 p.m.: 28 IR 3300, eff 90 days after filing with the Secretary of State)*)

**675 IAC 14-4.3-239.5 Section E3805.12.2.1; conductor fill**

Authority: IC 22-13-2-2; IC 22-13-2-13

Affected: IC 22-12; IC 22-13; IC 22-14; IC 22-15; IC 36-7

Sec. 239.5. After the first sentence of SECTION E3505.12.2.1, insert a new sentence to read as follows: A looped, unbroken conductor not less than twice the minimum length required for free conductors in SECTION E3306.10.3 shall be counted twice. (*Fire Prevention and Building Safety Commission; 675 IAC 14-4.3-239.5; filed Oct 21, 2005, 1:50 p.m.: 29 IR 810)*)

**675 IAC 14-4.3-240 Section E3806.5; in wall or ceiling**

Authority: IC 22-13-2-2; IC 22-13-2-13

Affected: IC 22-12; IC 22-13; IC 22-14; IC 22-15; IC 36-7

Sec. 240. In SECTION E3806.5, in the first sentence, after “tile”, insert “, gypsum, plaster” and, in the second sentence, after “combustible”, insert “surface”. (*Fire Prevention and Building Safety Commission; 675 IAC 14-4.3-240; filed Jun 13, 2005, 3:00 p.m.: 28 IR 3300, eff 90 days after filing with the Secretary of State*)

**675 IAC 14-4.3-241 Section E3806.8.2.1; nails and screws**

Authority: IC 22-13-2-2; IC 22-13-2-13

Affected: IC 22-12; IC 22-13; IC 22-14; IC 22-15; IC 36-7

Sec. 241. (a) Change the title of SECTION E3806.8.2.1 to “Nails and screws”. In the text, delete “Nails” and insert “Nails and screws”.

(b) Add a new sentence at the end of SECTION E3806.8.2.1 to read as follows: Screws shall not be permitted to pass through the box unless exposed threads in the box are protected using approved means to avoid abrasion of conductor insulation. (*Fire Prevention and Building Safety Commission; 675 IAC 14-4.3-241; filed Jun 13, 2005, 3:00 p.m.: 28 IR 3300, eff 90 days after filing with the Secretary of State; filed Oct 21, 2005, 1:50 p.m.: 29 IR 810*)

**675 IAC 14-4.3-241.5 Section E3807.2; damp or wet locations**

Authority: IC 22-13-2-2; IC 22-13-2-13

Affected: IC 22-12; IC 22-13; IC 22-14; IC 22-15; IC 36-7

Sec. 241.5. (a) At the end of SECTION E3807.2, add a new sentence to read as follows: For enclosures in wet locations, raceways or cables entering above the level of uninsulated live parts shall use fittings listed for wet locations.

(b) Add an exception to SECTION E3807.2 to read as follows: Exception: Nonmetallic enclosures shall be permitted to be installed without the airspace on a concrete, masonry, tile, or similar surface. (*Fire Prevention and Building Safety Commission; 675 IAC 14-4.3-241.5; filed Oct 21, 2005, 1:50 p.m.: 29 IR 810*)

**675 IAC 14-4.3-242 Section E3807.7; cables**

Authority: IC 22-13-2-2; IC 22-13-2-13

Affected: IC 22-12; IC 22-13; IC 22-14; IC 22-15; IC 36-7

Sec. 242. (a) At the end of Part 6 in the exception, delete “, the applicable article”.

(b) After Part 6 of the exception, add Part 7 to read as follows: Where installed as conduit or tubing, the allowable cable fill does not exceed that permitted for complete conduit or tubing systems by SECTION E3804.6. (*Fire Prevention and Building Safety Commission; 675 IAC 14-4.3-242; filed Jun 13, 2005, 3:00 p.m.: 28 IR 3300, eff 90 days after filing with the Secretary of State; filed Oct 21, 2005, 1:50 p.m.: 29 IR 810*)

**675 IAC 14-4.3-243 Section E3808.7; load-side equipment**

Authority: IC 22-13-2-2; IC 22-13-2-13

Affected: IC 22-12; IC 22-13; IC 22-14; IC 22-15; IC 36-7

Sec. 243. Add EXCEPTION 2 to SECTION E3808.7 to read as follows: EXCEPTION 2. It shall be permissible to ground meter enclosures by connection to the grounded circuit conductor on the load-side of the service if:

- (1) all meter enclosures are located near the service disconnecting means; and
- (2) the size of the grounded circuit conductor is not smaller than the size specified in TABLE E3808.12 for equipment grounding conductors.

(*Fire Prevention and Building Safety Commission; 675 IAC 14-4.3-243; filed Jun 13, 2005, 3:00 p.m.: 28 IR 3300, eff 90 days after filing with the Secretary of State*)



**675 IAC 14-4.3-244 Section E3808.8; types of equipment grounding conductors**

Authority: IC 22-13-2-2; IC 22-13-2-13

Affected: IC 22-12; IC 22-13; IC 22-14; IC 22-15; IC 36-7

Sec. 244. In SECTION E3808.8, delete the first sentence in Item 1 and insert “A copper, aluminum, or copper-clad aluminum conductor”. (*Fire Prevention and Building Safety Commission; 675 IAC 14-4.3-244; filed Jun 13, 2005, 3:00 p.m.: 28 IR 3300, eff 90 days after filing with the Secretary of State*)

**675 IAC 14-4.3-244.5 Section E3808.8.3; nonmetallic sheathed cable**

Authority: IC 22-13-2-2; IC 22-13-2-13

Affected: IC 22-12; IC 22-13; IC 22-14; IC 22-15; IC 36-7

Sec. 244.5. (a) In the first sentence of SECTION E3808.8.3, delete “be permitted to” without substitution.

(b) Delete the second sentence of SECTION E3808.8.3 without substitution. (*Fire Prevention and Building Safety Commission; 675 IAC 14-4.3-244.5; filed Oct 21, 2005, 1:50 p.m.: 29 IR 810*)

**675 IAC 14-4.3-245 Section E3901.3; indicating (Repealed)**

Sec. 245. (*Repealed by Fire Prevention and Building Safety Commission; filed Oct 21, 2005, 1:50 p.m.: 29 IR 815*)

**675 IAC 14-4.3-246 Section E3902.9; outdoor locations**

Authority: IC 22-13-2-2; IC 22-13-2-13

Affected: IC 22-12; IC 22-13; IC 22-14; IC 22-15; IC 36-7

Sec. 246. Delete SECTION E3902.9 without substitution. (*Fire Prevention and Building Safety Commission; 675 IAC 14-4.3-246; filed Jun 13, 2005, 3:00 p.m.: 28 IR 3301, eff 90 days after filing with the Secretary of State*)

**675 IAC 14-4.3-247 Section E3902.10; exterior wet locations**

Authority: IC 22-13-2-2; IC 22-13-2-13

Affected: IC 22-12; IC 22-13; IC 22-14; IC 22-15; IC 36-7

Sec. 247. (a) Delete the title of SECTION E3902.10 and substitute “Exterior wet locations”.

(b) In the first sentence of SECTION E3902.10, delete “other than outdoors” without substitution. (*Fire Prevention and Building Safety Commission; 675 IAC 14-4.3-247; filed Jun 13, 2005, 3:00 p.m.: 28 IR 3301, eff 90 days after filing with the Secretary of State; filed Oct 21, 2005, 1:50 p.m.: 29 IR 811*)

**675 IAC 14-4.3-247.5 Section E3902.11; bathtub and shower space**

Authority: IC 22-13-2-2; IC 22-13-2-13

Affected: IC 22-12; IC 22-13; IC 22-14; IC 22-15; IC 36-7

Sec. 247.5. Change SECTION E3902.11 to read as follows: A receptacle shall not be installed within or directly over a bathtub or shower stall. (*Fire Prevention and Building Safety Commission; 675 IAC 14-4.3-247.5; filed Oct 21, 2005, 1:50 p.m.: 29 IR 811*)

**675 IAC 14-4.3-248 Section E3902.13; outdoor installation**

Authority: IC 22-13-2-2; IC 22-13-2-13

Affected: IC 22-12; IC 22-13; IC 22-14; IC 22-15; IC 36-7

Sec. 248. Delete SECTION E3902.13 without substitution. (*Fire Prevention and Building Safety Commission; 675 IAC 14-4.3-248; filed Jun 13, 2005, 3:00 p.m.: 28 IR 3301, eff 90 days after filing with the Secretary of State*)

**675 IAC 14-4.3-248.5 Section E3903.10; bathtub and shower areas**

Authority: IC 22-13-2-2; IC 22-13-2-13

Affected: IC 22-12; IC 22-13; IC 22-14; IC 22-15; IC 36-7

Sec. 248.5. After the last sentence in SECTION E3903.10, add a new sentence to read as follows: Luminaires located in this zone shall be listed for damp locations or listed for wet locations where subject to shower spray. *(Fire Prevention and Building Safety Commission; 675 IAC 14-4.3-248.5; filed Oct 21, 2005, 1:50 p.m.: 29 IR 811)*

**675 IAC 14-4.3-249 Section E3903.11; fixtures in clothes closets**

Authority: IC 22-13-2-2; IC 22-13-2-13

Affected: IC 22-12; IC 22-13; IC 22-14; IC 22-15; IC 36-7

Sec. 249. In SECTION E3903.11, in Item 4, delete “on”. *(Fire Prevention and Building Safety Commission; 675 IAC 14-4.3-249; filed Jun 13, 2005, 3:00 p.m.: 28 IR 3301, eff 90 days after filing with the Secretary of State)*

**675 IAC 14-4.3-249.5 Section E4103.1.3; GFCI protection**

Authority: IC 22-13-2-2; IC 22-13-2-13

Affected: IC 22-12; IC 22-13; IC 22-14; IC 22-15; IC 36-7

Sec. 249.5. Add a new sentence to the end of SECTION E4103.1.3 to read as follows: Receptacles that supply pool pump motors and that are rated 15 or 20 amperes, 125 volts through 250 volts, single phase, shall be provided with GFCI protection. *(Fire Prevention and Building Safety Commission; 675 IAC 14-4.3-249.5; filed Oct 21, 2005, 1:50 p.m.: 29 IR 811)*

**675 IAC 14-4.3-250 Table E4103.5; overhead conductor clearances**

Authority: IC 22-13-2-2; IC 22-13-2-13

Affected: IC 22-12; IC 22-13; IC 22-14; IC 22-15; IC 36-7

Sec. 250. In TABLE E4103.5, in the second column, delete “22” and substitute “22.5” and delete “14” and substitute “14.5”. *(Fire Prevention and Building Safety Commission; 675 IAC 14-4.3-250; filed Jun 13, 2005, 3:00 p.m.: 28 IR 3301, eff 90 days after filing with the Secretary of State)*

**675 IAC 14-4.3-251 Section E4104.1; bonded parts (Repealed)**

Sec. 251. *(Repealed by Fire Prevention and Building Safety Commission; filed Oct 21, 2005, 1:50 p.m.: 29 IR 815)*

**675 IAC 14-4.3-252 Section E4106.8.2; other enclosures (Repealed)**

Sec. 252. *(Repealed by Fire Prevention and Building Safety Commission; filed Oct 21, 2005, 1:50 p.m.: 29 IR 815)*

**675 IAC 14-4.3-253 Section E4106.10; electrically operated pool covers (Repealed)**

Sec. 253. *(Repealed by Fire Prevention and Building Safety Commission; filed Oct 21, 2005, 1:50 p.m.: 29 IR 815)*

**675 IAC 14-4.3-254 Section E4106.12.2; permanently wired radiant heaters**

Authority: IC 22-13-2-2; IC 22-13-2-13

Affected: IC 22-12; IC 22-13; IC 22-14; IC 22-15; IC 36-7

Sec. 254. In SECTION E4106.12.2, after the second sentence, delete the period and insert “unless otherwise approved.”. *(Fire Prevention and Building Safety Commission; 675 IAC 14-4.3-254; filed Jun 13, 2005, 3:00 p.m.: 28 IR 3301, eff 90 days after filing with the Secretary of State)*

**675 IAC 14-4.3-254.5 Section E4107.2; ground-fault circuit-interrupters required**

Authority: IC 22-13-2-2; IC 22-13-2-13

Affected: IC 22-12; IC 22-13; IC 22-14; IC 22-15; IC 36-7

Sec. 254.5. Add a second paragraph at the end of SECTION E4107.2 to read as follows: All 125-volt receptacles located within 20 feet of the inside walls of a storable pool shall be protected by a ground-fault circuit interrupter. In determining these dimensions, the distance to be measured shall be the shortest path the supply cord of an appliance connected to the receptacle would follow without piercing a floor, wall, ceiling, doorway with hinged or sliding door, window opening, or other effective permanent barrier. *(Fire Prevention and Building Safety Commission; 675 IAC 14-4.3-254.5; filed Oct 21, 2005, 1:50 p.m.: 29 IR 811)*

**675 IAC 14-4.3-254.7 Section E4107.4; receptacle locations**

Authority: IC 22-13-2-2; IC 22-13-2-13

Affected: IC 22-12; IC 22-13; IC 22-14; IC 22-15; IC 36-7

Sec. 254.7. Add a new SECTION E4107.4; receptacle locations, with text to read as follows: Receptacles shall not be less than 10 feet from the inside walls of a pool. In determining these dimensions, the distance to be measured shall be the shortest path the supply cord of an appliance connected to the receptacle would follow without piercing a floor, wall, ceiling, doorway with hinged or sliding door, window opening, or other effective permanent barrier. *(Fire Prevention and Building Safety Commission; 675 IAC 14-4.3-254.7; filed Oct 21, 2005, 1:50 p.m.: 29 IR 811)*

**675 IAC 14-4.3-255 Section E4201.2; definitions**

Authority: IC 22-13-2-2; IC 22-13-2-13

Affected: IC 22-12; IC 22-13; IC 22-14; IC 22-15; IC 36-7

Sec. 255. In SECTION E4201.2, before the definition of Class 2 circuit, insert "ABANDONED CLASS 2 CABLE" and its definition to read as follows: Installed Class 2 cable that is not terminated at equipment and not identified for future use with a tag. *(Fire Prevention and Building Safety Commission; 675 IAC 14-4.3-255; filed Jun 13, 2005, 3:00 p.m.: 28 IR 3302, eff 90 days after filing with the Secretary of State)*

**675 IAC 14-4.3-256 Section E4201.3; spread of fire or products of combustion**

Authority: IC 22-13-2-2; IC 22-13-2-13

Affected: IC 22-12; IC 22-13; IC 22-14; IC 22-15; IC 36-7

Sec. 256. Add a new SECTION E4201.3 to the end of SECTION E4201 to read as follows: E4201.3 Spread of fire or products of combustion. The accessible portion of abandoned Class 2 cables shall not be permitted to remain. *(Fire Prevention and Building Safety Commission; 675 IAC 14-4.3-256; filed Jun 13, 2005, 3:00 p.m.: 28 IR 3302, eff 90 days after filing with the Secretary of State)*

**675 IAC 14-4.3-257 Chapter 43; referenced standards**

Authority: IC 22-13-2-2; IC 22-13-2-13

Affected: IC 22-12; IC 22-13; IC 22-14; IC 22-15; IC 36-7

Sec. 257. Delete, in the first paragraph of CHAPTER 43, "Section 102.4" and substitute to read as follows: SECTION R102. *(Fire Prevention and Building Safety Commission; 675 IAC 14-4.3-257; filed Jun 13, 2005, 3:00 p.m.: 28 IR 3302, eff 90 days after filing with the Secretary of State)*

**675 IAC 14-4.3-258 Appendix A; sizing and capacities of gas pipe**

Authority: IC 22-13-2-2; IC 22-13-2-13

Affected: IC 22-12; IC 22-13; IC 22-14; IC 22-15; IC 36-7

Sec. 258. Delete APPENDIX A. *(Fire Prevention and Building Safety Commission; 675 IAC 14-4.3-258; filed Jun 13, 2005,*

3:00 p.m.: 28 IR 3302, eff 90 days after filing with the Secretary of State)

**675 IAC 14-4.3-259 Appendix B; sizing of venting systems serving appliances equipped with draft hoods, Category 1 appliances, and appliances listed for use and Type B vents**

Authority: IC 22-13-2-2; IC 22-13-2-13

Affected: IC 22-12; IC 22-13; IC 22-14; IC 22-15; IC 36-7

Sec. 259. Delete APPENDIX B. (*Fire Prevention and Building Safety Commission; 675 IAC 14-4.3-259; filed Jun 13, 2005, 3:00 p.m.: 28 IR 3302, eff 90 days after filing with the Secretary of State*)

**675 IAC 14-4.3-260 Appendix C; exit terminals of mechanical draft and direct-vent systems**

Authority: IC 22-13-2-2; IC 22-13-2-13

Affected: IC 22-12; IC 22-13; IC 22-14; IC 22-15; IC 36-7

Sec. 260. Delete APPENDIX C. (*Fire Prevention and Building Safety Commission; 675 IAC 14-4.3-260; filed Jun 13, 2005, 3:00 p.m.: 28 IR 3302, eff 90 days after filing with the Secretary of State*)

**675 IAC 14-4.3-261 Appendix D; recommend procedure for safety inspection of an existing appliance installation**

Authority: IC 22-13-2-2; IC 22-13-2-13

Affected: IC 22-12; IC 22-13; IC 22-14; IC 22-15; IC 36-7

Sec. 261. Delete APPENDIX D. (*Fire Prevention and Building Safety Commission; 675 IAC 14-4.3-261; filed Jun 13, 2005, 3:00 p.m.: 28 IR 3302, eff 90 days after filing with the Secretary of State*)

**675 IAC 14-4.3-262 Appendix E; manufactured housing used as dwellings**

Authority: IC 22-13-2-2; IC 22-13-2-13

Affected: IC 22-12; IC 22-13; IC 22-14; IC 22-15; IC 36-7

Sec. 262. (a) Change the second paragraph of AE101.1 General to read as follows: AE 101.2 Applicability. These provisions shall be applicable only to a manufactured home or mobile home used as a dwelling unit on privately owned (nonrental) lots and shall apply to the following:

1. Construction or alteration of any foundation system that is necessary to provide for the installation of a manufactured home unit.
2. Construction, installation, addition, or alteration of the building service equipment that is necessary for connecting manufactured homes to water, fuel, or power supplies and sewage systems.
3. Alterations or additions to existing manufactured homes. The construction, alteration, and use of accessory buildings and structures and their building service equipment shall comply with the applicable requirements of the Indiana Residential Code (675 IAC 14).

These provisions shall not be applicable to the design and factory construction of manufactured homes nor shall they be deemed to authorize either modifications or additions to manufactured homes.

(b) Change subsection AE102.1 to read as follows: Manufactured homes and their building service equipment to which additions or alterations are made shall comply with all of the applicable requirements of the Indiana Residential Code (675 IAC 14) for new facilities.

(c) Change the title and text of subsection AE102.2 to read as follows: AE102.2 Additions. Additions made to a manufactured home shall conform to the requirements of this code and all other applicable Indiana codes. Additions shall be structurally independent from the manufactured home.

EXCEPTION: Structural independence need not be provided when:

- (1) structural calculations are provided to the building official confirming that the addition will not adversely affect the structural integrity of the manufactured home, or
- (2) the manufacturer of the home confirms, in writing, that the home will safely support the structural loads imposed by the proposed addition.

(d) Add subsection AE102.2.1 to read as follows: AE102.2.1 Alterations. Alterations may be made to any manufactured home or to its building service equipment without requiring the existing manufactured home or its building service equipment to comply with all the requirements of these provisions, provided the alteration or additions conform to that required for new construction, and provided further that no hazard to life, health, or safety will be created by such additions or alterations.

(e) Delete subsection AE102.3 without substitution.

(f) Change subsection AE102.4 to read as follows: The use or occupancy of any manufactured home shall not be changed unless evidence is provided to show compliance with the applicable rules of the Fire Prevention and Building Safety Commission for the new use or occupancy and be released for construction when required by the General Administrative Rules (675 IAC 12).

(g) Delete AE102.5 without substitution.

(h) Change subsection AE301.1 to read as follows: Where required by local ordinance, a manufactured home shall not be installed or altered without first obtaining a permit.

(i) Change the title and text of subsection AE301.2 to read as follows: AE301.2 Additions and alterations to a manufactured home. Where required by local ordinance, a permit shall be obtained to alter, remodel, or add accessory buildings or structures to a manufactured home.

(j) Delete subsection AE301.3 without substitution.

(k) Delete subsection AE301.4 without substitution.

(l) Delete SECTION AE302 without substitution.

(m) Delete SECTION AE303 without substitution.

(n) Delete SECTION AE304 without substitution.

(o) Delete SECTION AE305 without substitution.

(p) Delete SECTION AE306 without substitution.

(q) Delete SECTION AE307 without substitution.

(r) Change SECTION AE402 to read as follows: Manufactured homes and their accessory buildings shall be located on the property in accordance with the applicable sections of the Indiana Residential Code (675 IAC 14) and the ordinances of the jurisdiction in which the home is sited.

(s) Change the exception in subsection AE501.1 to read as follows: EXCEPTION: When specifically approved by the building official, foundation and anchoring systems that are constructed in accordance with the methods specified in Section A600 of this code.

(t) Change the text of AE502.1 to read as follows: Foundation systems designed and constructed in accordance with this section shall be considered as a permanent installation. Where the manufacturer's installation instructions and foundation design details for the home are available, the foundation system shall be installed in accordance with those instructions.

(u) Change subsection AE502.5 to read as follows: Provisions shall be made for the control and drainage of surface water away from the manufactured home in accordance with SECTION 401.3 of this code.

(v) Change subsection AE504 to read as follows: Accessory structures shall not be structurally supported by a manufactured home.

EXCEPTION: Structural independence need not be provided when:

1. structural calculations are provided to the building official confirming that the addition will not adversely affect the structural integrity of the manufactured home, or
2. the manufacturer of the home confirms, in writing, that the home will safely support the structural loads imposed by the proposed accessory structure.

(w) Change SECTION AE505 to read as follows: The alteration, replacement, or addition to the building service equipment, other than that required for the initial installation of the manufactured home, shall conform to the regulations set forth in this code.

(x) Delete subsection AE506.2 without substitution.

(y) Change subsection AE507 to read as follows: Alterations made to a manufactured home subsequent to its initial installation shall conform to the occupancy, fire safety, and energy conservation requirements set forth in, or referenced by, the applicable rules of the Fire Prevention and Building Safety Commission.

(z) Change AE604.1 to read as follows: Ground Anchors. Ground anchors shall be designed and installed to transfer the anchoring loads to the ground. The ground anchors shall be sized and installed to the full depth and as specified in the manufacturer's installation manual and shall be installed in undisturbed soil.

(aa) Change subsection AE604.3 to read as follows: All anchoring equipment exposed to weathering shall have a resistance to weather deterioration at least equivalent to that provided by a coating of zinc on steel of not less than 0.625 ounces per square foot

on each side of the surface coated.

(bb) Add a new SECTION AE701 Manufacturer's Installation Instructions to read as follows: Manufacturer's Installation Instructions. When the manufacturer's installation instructions are available, manufactured homes installed upon owned (nonrental) lots shall be installed per those installation instructions. *(Fire Prevention and Building Safety Commission; 675 IAC 14-4.3-262; filed Jun 13, 2005, 3:00 p.m.: 28 IR 3302, eff 90 days after filing with the Secretary of State)*

**675 IAC 14-4.3-263 Appendix F; radon control methods**

Authority: IC 22-13-2-2; IC 22-13-2-13

Affected: IC 22-12; IC 22-13; IC 22-14; IC 22-15; IC 36-7

Sec. 263. Delete APPENDIX F. *(Fire Prevention and Building Safety Commission; 675 IAC 14-4.3-263; filed Jun 13, 2005, 3:00 p.m.: 28 IR 3304, eff 90 days after filing with the Secretary of State)*

**675 IAC 14-4.3-264 Appendix G; swimming pools, spas, and hot tubs**

Authority: IC 22-13-2-2; IC 22-13-2-13

Affected: IC 22-12; IC 22-13; IC 22-14; IC 22-15; IC 36-7

Sec. 264. Delete APPENDIX G and substitute to read as follows: See the Indiana Swimming Pool Code (675 IAC 20). *(Fire Prevention and Building Safety Commission; 675 IAC 14-4.3-264; filed Jun 13, 2005, 3:00 p.m.: 28 IR 3304, eff 90 days after filing with the Secretary of State)*

**675 IAC 14-4.3-265 Appendix H; patio covers**

Authority: IC 22-13-2-2; IC 22-13-2-13

Affected: IC 22-12; IC 22-13; IC 22-14; IC 22-15; IC 36-7

Sec. 265. Delete APPENDIX H. *(Fire Prevention and Building Safety Commission; 675 IAC 14-4.3-265; filed Jun 13, 2005, 3:00 p.m.: 28 IR 3304, eff 90 days after filing with the Secretary of State)*

**675 IAC 14-4.3-266 Appendix I; private sewage disposal**

Authority: IC 22-13-2-2; IC 22-13-2-13

Affected: IC 22-12; IC 22-13; IC 22-14; IC 22-15; IC 36-7

Sec. 266. Delete APPENDIX I. *(Fire Prevention and Building Safety Commission; 675 IAC 14-4.3-266; filed Jun 13, 2005, 3:00 p.m.: 28 IR 3304, eff 90 days after filing with the Secretary of State)*

**675 IAC 14-4.3-267 Appendix J; existing buildings and structures**

Authority: IC 22-13-2-2; IC 22-13-2-13

Affected: IC 22-12; IC 22-13; IC 22-14; IC 22-15; IC 36-7

Sec. 267. Delete APPENDIX J and substitute to read as follows: See the General Administrative Rules (675 IAC 12) and local ordinance. *(Fire Prevention and Building Safety Commission; 675 IAC 14-4.3-267; filed Jun 13, 2005, 3:00 p.m.: 28 IR 3304, eff 90 days after filing with the Secretary of State)*

**675 IAC 14-4.3-268 Appendix K; sound transmission**

Authority: IC 22-13-2-2; IC 22-13-2-13

Affected: IC 22-12; IC 22-13; IC 22-14; IC 22-15; IC 36-7

Sec. 268. Delete APPENDIX K. *(Fire Prevention and Building Safety Commission; 675 IAC 14-4.3-268; filed Jun 13, 2005, 3:00 p.m.: 28 IR 3304, eff 90 days after filing with the Secretary of State)*

**675 IAC 14-4.3-269 Appendix L; ICC International Residential Electrical Provisions/National Electrical Code Cross Reference**

Authority: IC 22-13-2-2; IC 22-13-2-13

Affected: IC 22-12; IC 22-13; IC 22-14; IC 22-15; IC 36-7

Sec. 269. Delete APPENDIX L. (*Fire Prevention and Building Safety Commission; 675 IAC 14-4.3-269; filed Jun 13, 2005, 3:00 p.m.; 28 IR 3304, eff 90 days after filing with the Secretary of State*)

\*